

IN2SAFE

NEW 2018 CATALOGUE



Safety Signs



Traffic Signs



Safety Lockout

IN2SAFE

SAFETY SIGNAGE

We offer a full range of safety signage for all applications. With a wide range of standard designs and the ability to customise to suit specific needs nothing is out of reach. Our most popular materials are 2mm Rigid PVC, Self-Adhesive Vinyl Stickers or 4mm Aluminium Composite Material (ACM), but we can also offer 1.2mm Electro-galv steel for Magnetic receptive signs, 5mm Corflute for Promotional / Short Term signage and many other substrates if required. All our signage is manufactured using Premium European Vinyl's and Overlaminates to give a 5 year outdoor Durability, we can also offer 7 – 10 year options if required. With many different options of Over laminate you can tailor the finish & performance of your signage to each application, maximising the impact while ensuring that the performance is not compromised. Laminates include Clear Gloss, Clear Matte, Whiteboard Surface, Anti-Skid, Anti-Graffiti and a range of Translucent Colours used in conjunction with a high Grade reflective. All these options are backed by our comprehensive warranty and are usually dispatched with 24 hours of confirmation of order or proofs.

IN2SAFE

TRAFFIC SIGNAGE

We manufacture all Traffic signs to NZTA specifications, using approved Reflective materials and Designs. We can also offer a full range of Mounting Brackets, Poles and accessories for Permanent signs and can source Temporary Sign stands, Cones and other Traffic control products as required. Along with the standard range of Traffic Signage we also specialise in producing custom signage for the Forestry & Heavy Construction Industries for off road use. These custom signs are designed with a similar format to regular Traffic signs to ensure that both the impact is maximised and they can be easily fitted to standard Traffic sign stands. Our strength is our flexibility & Production Speed with this range, we can offer Logo printing on these signs with no set up cost and no minimum quantity, and can produce your order and dispatch with 24-48 hours in most situations.

IN2SAFE

LOCKOUT SYSTEMS

We stock a comprehensive range of Safety Lockout Products to allow for small through to complex lockout requirements. From small contractors packs to highly customised systems for High Risk environments we have the range to cater for all your requirements. We stock a wide range of padlocks, with multiple colour options and both Keyed Alike and Keyed Different configuration. We can also customise packages utilising keyed alike groups and master keys to enable complex multi-level lockout abilities. With our in house printing capabilities we can also provide Padlocks with individual Names & Photo ID stickers. Aside from our stocked range of Padlocks, Electrical Lockouts, Valve Lockouts, Key Cabinets, Lockout Stations, Tags and Universal type lockouts, we can also special order many other more specialised products on demand.

4	Section 1 - In2safe Safety Signs
5	CAUTION SIGNS
11	DANGER SIGNS
17	EXIT SIGNS
21	FIRE SIGNS
23	FIRST AID SIGNS
25	FLOOR & FOOTPATH SIGNS
27	GENERAL SIGNS
38	HAZARD BOARDS
44	HAZCHEM SIGNS
47	DIESEL TANK STICKERS
48	HYGIENE & DISABILITY SIGNS
55	MANDATORY SIGNS
50	NOTICE SIGNS
53	PROHIBITION SIGNS
58	SECURITY SIGNS
59	TRAFFIC SIGNS
63	WARNING SIGNS
65	FORESTRY SIGNAGE
66	SIGN MOUNTING HARDWARE
69	Section 2 - In2safe Traffic Signs
70	TEMPORARY TRAFFIC SIGNS
72	OVER DIMENSION SIGNAGE
74	TRAFFIC CONTROL
75	HPMV & 0800 LOG TRUCK SIGNS
76	TRANSPORT & MACHINE STICKERS
77	Section 3 - In2safe Safety Lockout
78	LOCKOUT PADLOCKS
83	LOCKOUT VALVES
85	LOCKOUT HASPS
87	ELECTRICAL LOCKOUT
89	BAGS & KEY STATIONS
90	LOCKOUT & PADLOCK STATIONS

IN²SAFE

SAFETY SIGNAGE



DESIGN YOUR OWN CUSTOM CAUTION SIGNS



VC7000

Available in the following Sizes;

M - 150 x 200mm, A - 225 x 300mm, B - 300 x 400mm,
C - 450 x 600mm, D - 600 x 800mm, Y - 900 x 1200mm.

Available in the following Materials;

A - ACM (4mm Aluminium Composite Material), P - PVC
(2mm Rigid PVC Board), S - SAV (Self Adhesive Vinyl Sticker).



VC7500

Available in the following Sizes;

M - 200 x 150mm, A - 300 x 225mm, B - 400 x 300mm,
C - 600 x 450mm, D - 800 x 600mm, Y - 1200 x 900mm.

Available in the following Materials;

A - ACM (4mm Aluminium Composite Material), P - PVC
(2mm Rigid PVC Board), S - SAV (Self Adhesive Vinyl Sticker).



VC7600

Available in the following Sizes;

M - 200 x 150mm, A - 300 x 225mm, B - 400 x 300mm,
C - 600 x 450mm, D - 800 x 600mm, Y - 1200 x 900mm.

Available in the following Materials;

A - ACM (4mm Aluminium Composite Material), P - PVC
(2mm Rigid PVC Board), S - SAV (Self Adhesive Vinyl Sticker).



VC7700

Available in the following Sizes;

O - 75 x 75mm, G - 100 x 100mm, L - 150 x 150mm,
R - 200 x 200mm, Z - 300 x 300mm, W - 400 x 400mm

Available in the following Materials;

S - SAV (Self Adhesive Vinyl Sticker).



VC7800

Available in the following Sizes;

O - 75 x 75mm, G - 100 x 100mm, L - 150 x 150mm,
R - 200 x 200mm, Z - 300 x 300mm, W - 400 x 400mm

Available in the following Materials;

S - SAV (Self Adhesive Vinyl Sticker).

STANDARD ICONS AVAILABLE

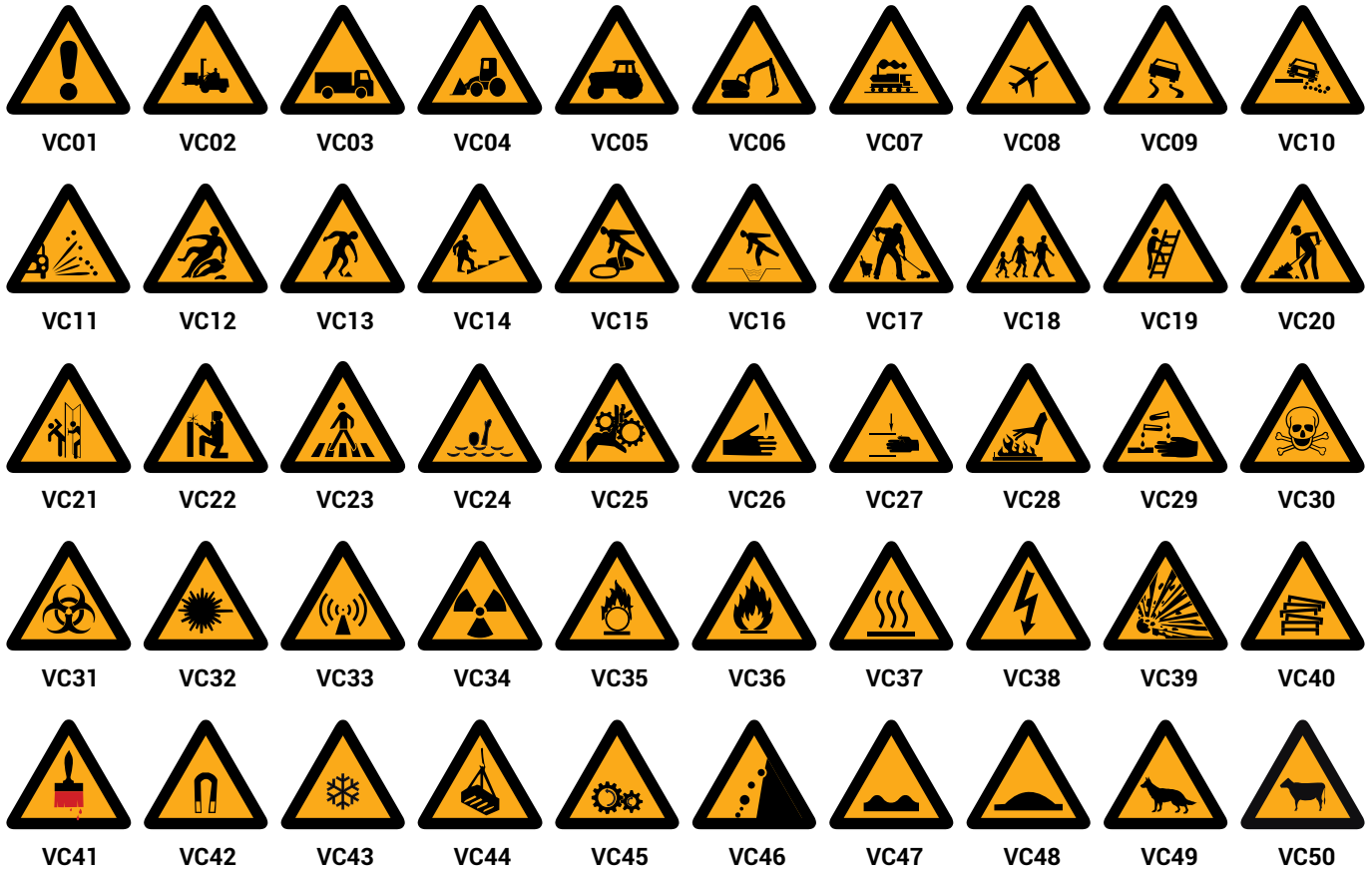

TO ORDER: When placing your order please reference the product code off the opposing page followed by the letter to designate Size and then the letter to designate Material. The Size and Material options are noted next to each template on the opposite page. Then note the Icon you require using the codes above and finally the Text that you require on the sign.

For example the custom 300x400mm PVC sign to the right would be specified in the following manner;

VC7000BP - VC08 - "Aircraft Passing Overhead"





VC7001



VC7002



VC7003



VC7004



VC7005



VC7006



VC7007



VC7008



VC7009



VC7010



VC7011



VC7012



VC7013



VC7014



VC7015



VC7016



VC7017



VC7018



VC7019



VC7020



VC7021



VC7022



VC7023



VC7024



VC7025



VC7026



VC7027



VC7028



VC7029



VC7030

TO ORDER: When placing your order please reference the product code followed by one of the following letters to specify the size of the sign. A - 225 x 300mm, B - 300 x 400mm, C - 450 x 600mm, D - 600 x 800mm

Then add a second letter as follows to specify the material. A - ACM (4mm Aluminium Composite Material), P - PVC (2mm Rigid PVC Board), S - SAV (Self Adhesive Vinyl Sticker). For Example a 300 x 400mm PVC Sign code would look like VC7003BP



VC7031



VC7032



VC7033



VC7034



VC7035



VC7036



VC7037



VC7038



VC7039



VC7040



VC7041



VC7042



VC7043



VC7044



VC7045



VC7046



VC7047



VC7048



VC7049



VC7050

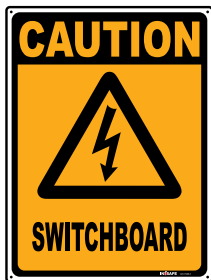

VC7051



VC7052



VC7053



VC7054



VC7055



VC7056



VC7057



VC7058



VC7059



VC7060

TO ORDER: When placing your order please reference the product code followed by one of the following letters to specify the size of the sign. A - 225 x 300mm, B - 300 x 400mm, C - 450 x 600mm, D - 600 x 800mm

Then add a second letter as follows to specify the material. A - ACM (4mm Aluminium Composite Material), P - PVC (2mm Rigid PVC Board), S - SAV (Self Adhesive Vinyl Sticker). For Example a 300 x 400mm PVC Sign code would look like VC7059BP



VC7501



VC7502



VC7503



VC7504



VC7505



VC7506



VC7507



VC7508



VC7509



VC7510



VC7511



VC7512



VC7513



VC7514



VC7515



VC7516



VC7517



VC7518



VC7519



VC7520



VC7521



VC7522



VC7523



VC7524



VC7525

TO ORDER: When placing your order please reference the product code followed by one of the following letters to specify the size of the sign. A - 300 x 225mm, B - 400 x 300mm, C - 600 x 450mm, D - 800 x 600mm

Then add a second letter as follows to specify the material. A - ACM (4mm Aluminium Composite Material), P - PVC (2mm Rigid PVC Board), S - SAV (Self Adhesive Vinyl Sticker). For Example a 400 x 300mm PVC Sign code would look like VC7516BP



VFG7010 - Anti Skid Floor Graphic - 600x100mm



VFG7011 - Anti Skid Floor Graphic - 600x100mm

Anti-skid Floor Graphics are for use when there is no space for conventional signage. They are supplied as a self adhesive sticker and have a very strong adhesive which will adhere to all regular floor surfaces including carpet. The surface is a non-slip and is suitable for high traffic areas.

DESIGN YOUR OWN CUSTOM DANGER SIGNS



VD7000

Available in the following Sizes;

M - 150 x 200mm, A - 225 x 300mm, B - 300 x 400mm,
C - 450 x 600mm, D - 600 x 800mm, Y - 900 x 1200mm.

Available in the following Materials;

A - ACM (4mm Aluminium Composite Material), P - PVC
(2mm Rigid PVC Board), S - SAV (Self Adhesive Vinyl Sticker).



VD7500

Available in the following Sizes;

M - 200 x 150mm, A - 300 x 225mm, B - 400 x 300mm,
C - 600 x 450mm, D - 800 x 600mm, Y - 1200 x 900mm.

Available in the following Materials;

A - ACM (4mm Aluminium Composite Material), P - PVC
(2mm Rigid PVC Board), S - SAV (Self Adhesive Vinyl Sticker).



VD7700

Available in the following Sizes;

M - 200 x 150mm, A - 300 x 225mm, B - 400 x 300mm,
C - 600 x 450mm, D - 800 x 600mm, Y - 1200 x 900mm.

Available in the following Materials;

A - ACM (4mm Aluminium Composite Material), P - PVC
(2mm Rigid PVC Board), S - SAV (Self Adhesive Vinyl Sticker).

TO ORDER: When placing your order please reference the product code, followed by the letter to designate Size and then the letter to designate Material. The Size and Material options are noted next to each template. Then note the Text that you require on the sign.

For example the custom 400x300mm PVC sign to the right would be specified in the following manner;

VD7500BP - "This is an Example Sign"





VD7001



VD7002



VD7003

Site Hazard Boards
see Pages 28, 28 & 30



VD7004



VD7005



VD7006

TO ORDER: When placing your order please reference the product code followed by one of the following letters to specify the size of the sign. A - 225 x 300mm, B - 300 x 400mm, C - 450 x 600mm, D - 600 x 800mm

Then add a second letter as follows to specify the material. A - ACM (4mm Aluminium Composite Material), P - PVC (2mm Rigid PVC Board), S - SAV (Self Adhesive Vinyl Sticker). For Example a 300 x 400mm PVC Sign code would look like VD7004BP



VD7501



VD7502



VD7503



VD7504



VD7505



VD7506



VD7507



VD7508



VD7509



VD7510

TO ORDER: When placing your order please reference the product code followed by one of the following letters to specify the size of the sign. A - 300 x 225 mm, B - 400 x 300mm, C - 600 x 450mm, D - 800 x 600mm

Then add a second letter as follows to specify the material. A - ACM (4mm Aluminium Composite Material), P - PVC (2mm Rigid PVC Board), S - SAV (Self Adhesive Vinyl Sticker). For Example a 300 x 400mm PVC Sign code would look like VD7503BP



VD7511



VD7512



VD7513

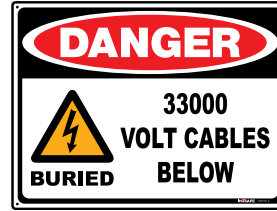

VD7514



VD7515



VD7516



VD7517



VD7518



VD7519



VD7520



VD7521



VD7522



VD7523



VD7524



VD7525



VD7526



VD7527



VD7528



VD7529



VD7530



VD7531



VD7532



VD7533



VD7534



VD7535



VD7536



VD7537



VD7538



VD7539



VD7540

TO ORDER: When placing your order please reference the product code followed by one of the following letters to specify the size of the sign. A - 300 x 225 mm, B - 400 x 300mm, C - 600 x 450mm, D - 800 x 600mm

Then add a second letter as follows to specify the material. A - ACM (4mm Aluminium Composite Material), P - PVC (2mm Rigid PVC Board), S - SAV (Self Adhesive Vinyl Sticker). For Example a 300 x 400mm PVC Sign code would look like VD7548BP



VD7541



VD7542



VD7543



VD7544



VD7545



VD7546



VD7548



VD7549



VD7550



VD7551



VD7552



VD7553



VD7554



VD7555



VD7556



VD7557



VD7558



VD7559



VD7560



VD7561



VD7562



VD7563



VD7564



VD7565



VD7566



VD7567



VD7568



VD7569



VD7570



VD7571

TO ORDER: When placing your order please reference the product code followed by one of the following letters to specify the size of the sign. A - 300 x 225 mm, B - 400 x 300mm, C - 600 x 450mm, D - 800 x 600mm

Then add a second letter as follows to specify the material. A - ACM (4mm Aluminium Composite Material), P - PVC (2mm Rigid PVC Board), S - SAV (Self Adhesive Vinyl Sticker). For Example a 300 x 400mm PVC Sign code would look like VD7579BP



VD7572



VD7573



VD7574



VD7575



VD7576



VD7577



VD7578



VD7579



VD7580



VD7581



VD7582



VD7583



VD7584



VD7585



VD7586



VD7587



VD7588



VD7589



VD7590



VD7591



VD7592



VD7593



VD7594



VD7595



VD7596



VD7597



VD7598

TO ORDER: When placing your order please reference the product code followed by one of the following letters to specify the size of the sign. A - 300 x 225 mm, B - 400 x 300mm, C - 600 x 450mm, D - 800 x 600mm

Then add a second letter as follows to specify the material. A - ACM (4mm Aluminium Composite Material), P - PVC (2mm Rigid PVC Board), S - SAV (Self Adhesive Vinyl Sticker). For Example a 300 x 400mm PVC Sign code would look like VD7593BP





VE7501



VE7503



VE7506



VE7511



VE7515



VE7517



VE7519



VE7523



VE7531



VE7533



VE7534



VE7535



VE7536



VE7538



VE7540



VE7541



VE7544



VE7545

TO ORDER: When placing your order please reference the product code followed by one of the following letters to specify the size of the sign. N - 300 x 150mm, S - 400 x 200mm, J - 600 x 300mm

Then add a second letter as follows to specify the material. A - ACM (4mm Aluminium Composite Material), P - PVC (2mm Rigid PVC Board), S - SAV (Self Adhesive Vinyl Sticker). For Example a 300 x 150mm PVC Sign code would look like VE7501NP



VE7502



VE7504



VE7505



VE7507



VE7508



VE7509



VE7510



VE7512



VE7513



VE7514



VE7522



VE7524



VE7525



VE7528

TO ORDER: When placing your order please reference the product code followed by one of the following letters to specify the size of the sign. A - 300 x 225 mm, B - 400 x 300mm, C - 600 x 450mm, D - 800 x 600mm

Then add a second letter as follows to specify the material. A - ACM (4mm Aluminium Composite Material), P - PVC (2mm Rigid PVC Board), S - SAV (Self Adhesive Vinyl Sticker). For Example a 300 x 400mm PVC Sign code would look like VE7502BP



VE7530



VE7532



VE7537



VE7542

TO ORDER: When placing an order reference the product code followed by the letter to specify the size of the sign. T - 450 x 200mm Then add a second letter as follows to specify the material. A - ACM (4mm Aluminium Composite Material), P - PVC (2mm Rigid PVC Board), S - SAV (Self Adhesive Vinyl Sticker). For Example a 450 x 200mm PVC Sign code would look like VE7530TP

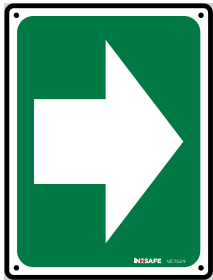

VE7529

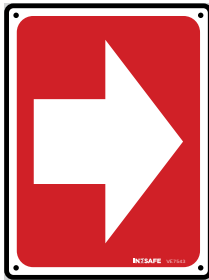

VE7543



VE7521



VE7526

TO ORDER: When placing your order please reference the product code followed by one of the following letters to specify the size of the sign. Z - 400 x 100mm, Q - 600 x 150mm

TO ORDER: When placing an order reference the product code followed by the letter to specify the size of the sign. K - 300 x 100mm

TO ORDER: When placing your order please reference the product code followed by one of the following letters to specify the size of the sign. M - 150 x 200mm, A - 225 x 300mm, B - 300 x 400mm, C - 450 x 600mm

Then add a second letter as follows to specify the material. A - ACM (4mm Aluminium Composite Material), P - PVC (2mm Rigid PVC Board), S - SAV (Self Adhesive Vinyl Sticker). For Example a 150 x 200mm PVC Sign code would look like VE7529MP

LUMINOUS EXIT SIGNS



VE7601



VE7603



VE7606



VE7611



VE7615



VE7617



VE7619



VE7623



VE7631



VE7633



VE7634



VE7635



VE7636



VE7638



VE7640



VE7641



VE7644



VE7645

TO ORDER: When placing your order please reference the product code followed by one of the following letters to specify the size of the sign. N - 300 x 150mm, S - 400 x 200mm, J - 600 x 300mm

Then add a second letter as follows to specify the material. A - ACM (4mm Aluminium Composite Material), P - PVC (2mm Rigid PVC Board), S - SAV (Self Adhesive Vinyl Sticker). For Example a 300 x 150mm PVC Sign code would look like VE7601NP



Face Mounted Emergency Exit Signs to meet **NZBC F8**

Since April 2012 the Building Code Acceptable Solution for emergency exit signage (F8/AS1) has allowed photoluminescent ("PL") exit signs to be used wherever "illuminated exit signs" are required.

There are strict performance requirements specified in F8/AS1 that make sure the PL signs will meet all the requirements of the NZ building code. To the best of our knowledge, Ecoglo signs are the only PL signs available in New Zealand that are bright enough to meet F8/AS1.

Ecoglo's Emergency Exit Signs are manufactured and tested to comply with F8/AS1. They are also designed to be used in engineered solutions to meet building codes in Australia, New Zealand and any performance based jurisdiction around the world.

Ecoglo's high visibility and durability ensure that the signs can be installed in any environment, indoors or outdoors. As long as there is sufficient natural or artificial light to charge the signs then a system can be engineered to meet building code performance specifications.



Exit
Exit straight on from here
Code: VE7700 - Max Viewing Distance 16M
Size: 230x133mm
Code: VE7701 - Max Viewing Distance 24M
Size: 290x162mm



Pictogram Uni
Exit straight on from here
Code: VE7702 - Max Viewing Distance 16M
Size: 162x162mm
Code: VE7703 - Max Viewing Distance 24M
Size: 230x230mm



Pictogram
Exit straight on from here
Code: VE7713 - Max Viewing Distance 16M
Size: 290x162mm
Code: VE7714 - Max Viewing Distance 24M
Size: 420x230mm



Pictogram Hi Vis
Exit straight on from here
Code: VE7715 - Max Viewing Distance 16M
Size: 290x162mm
Code: VE7716 - Max Viewing Distance 24M
Size: 420x230mm



Arrow
Travel in this direction
Code: VE7721 - Max Viewing Distance 16M
Size: 133x133mm - Use with VE7700
Code: VE7711 - Max Viewing Distance 16M
Size: 162x162mm - Use with VE7701 & VE7702
Code: VE7712 - Max Viewing Distance 24M
Size: 230x230mm - Use with VE7703



Pictogram Right
Exit right from here
Max Viewing Distance 16M, Size: 290x162mm
Single Sided Code: VE7706
Double Sided Code: VE7706D
Max Viewing Distance 24M, Size: 420x230mm
Single Sided Code: VE7707
Double Sided Code: VE7707D



Pictogram Left
Exit left from here
Max Viewing Distance 16M, Size: 290x162mm
Single Sided Code: VE7704
Double Sided Code: VE7704D
Max Viewing Distance 24M, Size: 420x230mm
Single Sided Code: VE7705
Double Sided Code: VE7705D



Pictogram Double Arrow
Exit right or left from here
Max Viewing Distance 16M, Size: 290x162mm
Single Sided Code: VE7717
Double Sided Code: VE7717D
Max Viewing Distance 24M, Size: 420x230mm
Single Sided Code: VE7718
Double Sided Code: VE7718D



Pictogram Double Arrow Hi Vis
Exit right or left from here
Max Viewing Distance 16M, Size: 290x162mm
Single Sided Code: VE7719
Double Sided Code: VE7719D
Max Viewing Distance 24M, Size: 420x230mm
Single Sided Code: VE7720
Double Sided Code: VE7720D



No Exit
Do not use door to exit in an emergency
Code: VE7710 - Max Viewing Distance 16M
Size: 410x133mm



Emergency Exit
Use this door only to exit in an emergency
Code: VE7708 - Max Viewing Distance 16M, Size: 610x280mm
Code: VE7709 - Max Viewing Distance 24M, Size: 785x350mm





VF7003
(Without Alarm)



VF7004
(With Alarm)



VF7005



VF7006



VF7007



VF7008



VF7009



VF7010



VF7011



VF7015



VF7016



VF7017

TO ORDER: When placing your order please reference the product code followed by one of the following letters to specify the size of the sign. A - 225 x 300mm, B - 300 x 400mm, C - 450 x 600mm, D - 600 x 800mm

Then add a second letter as follows to specify the material. A - ACM (4mm Aluminium Composite Material), P - PVC (2mm Rigid PVC Board), S - SAV (Self Adhesive Vinyl Sticker). For Example a 300 x 400mm PVC Sign code would look like VF7007BP



VF7200



VF7201



VF7202



VF7203



VF7204

TO ORDER: When placing your order please reference the product code followed by one of the following letters to specify the size of the sign. M - 200 x 150mm, A - 300x 225mm, B - 400 x 300mm, C - 600 x 450mm, D - 600 x 800mm

Then add a second letter as follows to specify the material. A - ACM (4mm Aluminium Composite Material), P - PVC (2mm Rigid PVC Board), S - SAV (Self Adhesive Vinyl Sticker). For Example a 400 x 300mm PVC Sign code would look like VF7201BP



VF7013



VF7014



VF7019



VF7020



VF7021



VF7022

TO ORDER: When placing your order please reference the product code followed by one of the following letters to specify the size of the sign. N - 150 x 300mm, S - 200 x 400mm, J - 300 x 600mm

Then add a second letter as follows to specify the material. A - ACM (4mm Aluminium Composite Material), P - PVC (2mm Rigid PVC Board), S - SAV (Self Adhesive Vinyl Sticker). For Example a 200 x 400mm PVC Sign code would look like VF7014SP



VF7001



VF7002



VF7012



VF7035



VF7036

TO ORDER: When placing your order please reference the product code followed by one of the following letters to specify the size of the sign. O - 75 x 75mm, G - 100 x 100mm, L - 150 x 150mm, R - 200 x 200mm, Z - 300 x 300mm, W - 400 x 400mm

Then add a second letter as follows to specify the material. A - ACM (4mm Aluminium Composite Material), P - PVC (2mm Rigid PVC Board), S - SAV (Self Adhesive Vinyl Sticker). For Example a 100 x 100mm PVC Sign code would look like VF7002GP

TO ORDER: When placing your order please reference the product code followed by one of the following letters to specify the size of the sign. Z - 130 x 350mm

Then add a second letter to specify the material. A - ACM (4mm Aluminium Composite Material), P - PVC (2mm Rigid PVC Board), S - SAV (Self Adhesive Vinyl Sticker). For Example a 130 x 350mm PVC Sign code would look like VF7012ZP



VF7101



VF7102



VF7103



VF7104



VF7105



VF7106



VF7107

TO ORDER: When placing your order please reference the product code followed the following letter to specify the size of the sign. Z - 230 x 230 x 230mm Triangle

Then add a second letter as follows to specify the material. P - PVC (2mm Rigid PVC Board), S - SAV (Self Adhesive Vinyl Sticker). For Example a 230 x 230 x 230mm PVC Sign code would look like VF7101ZP

FIRE WARDEN ARM BANDS & VESTS



Hi Vis Vest
with Fire Warden Logo
PCV1506-FLYE - Yellow
PCV1506-FLOR - Orange

Available in the following Sizes
XXXS, XXS, XS, S - 6XL & 8XL



Hi Vis Arm Bands
with Velcro Strap
PCA1000-YE - Yellow
PCA1000-OR - Orange



VF7002IS - 75x75mm

Reversed Fire Extinguisher Sticker - For inside Vehicle windows to indicate the position of the Fire Extinguisher

**For Fire Exit signs
see Pages 16 & 18**



VF7514



VF7506



VF7515



VF7507



VF7505



VF7502



VF7503



VF7509



VF7508



VF7537



VF7501



VF7517



VF7536



VF7500

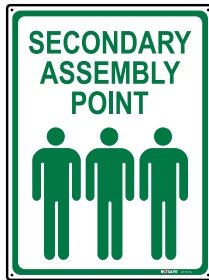

VF7516



VF7504



VF7542



VF7543



VF7532



VF7533



VF7544



VF7605

+ SAFETY RECORD +	
LOST TIME INJURIES THIS MONTH	<input type="text"/>
LOST TIME INJURIES THIS YEAR	<input type="text"/>
DAYS SINCE LAST LOST TIME INJURY	<input type="text"/>
PREVIOUS RECORD	<input type="text"/>
SAFETY IS EVERYONE'S RESPONSIBILITY	

IN2SAFE
VHS7000

- VHS7000 - 1200x600mm - ACM - Standard Laminate Finish
- VHS7000WB - 1200x600mm - ACM - Whiteboard Laminate Finish
- VHS7000ES - 1200x600mm - 1.2mm Egalv Steel (For Mag Numbers)
- VHSNUM - Set of 30 Magnetic Numbers (3 of each 0-9)

TO ORDER: When placing your order please reference the product code followed by one of the following letters to specify the size of the sign. A - 225 x 300mm, B - 300 x 400mm, C - 450 x 600mm, D - 600 x 800mm
Then add a second letter as follows to specify the material. A - ACM (4mm Aluminium Composite Material), P - PVC (2mm Rigid PVC Board), S - SAV (Self Adhesive Vinyl Sticker). For Example a 300 x 400mm PVC Sign code would look like VF7500BP

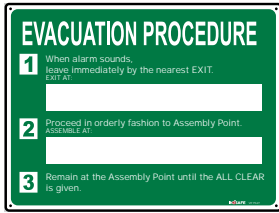

VF7527



VF7606



VF7545



VF7546



VF7529



VF7534



VF7601



VF7604



VF7602



VF7607



VF7600



VF7701



VF7801

TO ORDER: When placing your order please reference the product code followed by one of the following letters to specify the size of the sign. A - 300 x 225 mm, B - 400 x 300mm, C - 600 x 450mm, D - 800 x 600mm

Then add a second letter as follows to specify the material. A - ACM (4mm Aluminium Composite Material), P - PVC (2mm Rigid PVC Board), S - SAV (Self Adhesive Vinyl Sticker). For Example a 300 x 400mm PVC Sign code would look like VF7527BP



VF7510



VF7511



VF7512



VF7513



VF7541



VF7547



VF7531

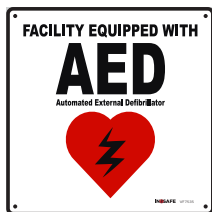

VF7535



VF7510IS - 75x75mm

Reversed First Aid Sticker - For inside Vehicle windows to indicate the position of the First Aid Kit

TO ORDER: When placing your order please reference the product code followed by one of the following letters to specify the size of the sign. O - 75 x 75mm, G - 100 x 100mm, L - 150 x 150mm, R - 200 x 200mm, Z - 300 x 300mm, W - 400 x 400mm

Then add a second letter as follows to specify the material. A - ACM (4mm Aluminium Composite Material), P - PVC (2mm Rigid PVC Board), S - SAV (Self Adhesive Vinyl Sticker). For Example a 100 x 100mm PVC Sign code would look like VF7510GP

THE REVOLUTIONARY

BANANA CONE!







The glossy yellow Banana Cone™ is already revolutionising the way warning messages are displayed overseas and is now available in New Zealand.

With the warning message inherent in the shape of the cone, these are a must for all situations where easy and quick recognition of warning signs is essential.

STAND OUT FROM THE BUNCH!



Features & Benefits

-  Printed on all four sides rather than two sides like traditional free standing warning signs
-  The banana peel being naturally associated with something slippery means that the warning cone also has a strong message inherent in the shape of the cone
-  Easy stacking and durable plastic makes for ease of storage and long life
-  Wide sturdy base and weight of 910 grams ensures cone will not blow over if used outdoors
-  Patented, trademarked design ensures value for resellers

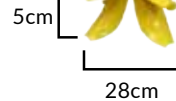

WET FLOOR
Code: VBC701

SLIPPERY FLOOR
Code: VBC702

CLEANING IN PROGRESS
Code: VBC703



*Also available as blank cones (code #VBC700) and with custom messages on request.

www.bananaproducts.co.nz



VW7900 - Custom Sign from Blank Board above using your design & text



VW7901



VW7902



VW7903



VW7904



VW7905



VW7906



VW7907



VW7909



VW7913



VW7915



VW7916



VW7917



VW7918



VW7919



VW7920



VW7921



VW7922



VW7923

FOOTPATH SIGNS

ANTI-SKID FLOOR GRAPHICS

Footpath signs are comprised of a Sturdy Plastic Base which can be water filled and a 4mm ACM sign blade, 600mm wide x 800mm High. They can be printed single or Double sided and can be reflective if required.

To order email your design to sales@in2safesigns.co.nz

Code: VF7901B



Anti-skid Floor Graphics are for use when there is no space for conventional signage. They are supplied as a self adhesive sticker and have a very strong adhesive which will adhere to all regular floor surfaces including carpet. The surface is a non-slip and is suitable for high traffic areas. We can print any of the signage designs in this catalogue as Floor Graphics and also any custom Designs & Advertising as required.



DESIGN YOUR OWN CUSTOM SIGNS



VG7000

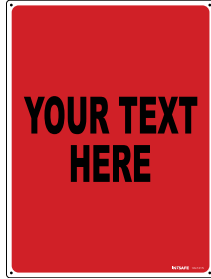

VG7415

Available in the following Sizes;
M - 150 x 200mm, A - 225 x 300mm, B - 300 x 400mm,
C - 450 x 600mm, D - 600 x 800mm, Y - 900 x 1200mm. **Available in the following Materials;**
A - ACM (4mm Aluminium Composite Material), P - PVC (2mm Rigid PVC Board), S - SAV (Self Adhesive Vinyl Sticker).



VG7500



VG7410



VG7420



VG7430



VG7440



VG7450



VG7460



VG7470



VG7480

Available in the following Sizes;

M - 200 x 150mm, A - 300 x 225mm, B - 400 x 300mm, C - 600 x 450mm, D - 800 x 600mm, Y - 1200 x 900mm.

Available in the following Materials;

A - ACM (4mm Aluminium Composite Material), P - PVC (2mm Rigid PVC Board), S - SAV (Self Adhesive Vinyl Sticker).



VC7600

Available in the following Sizes;
H - 200 x 70mm, P - 400 x 150mm
Available in the following Materials;
A - ACM (4mm Aluminium Composite Material), P - PVC (2mm Rigid PVC Board), S - SAV (Self Adhesive Vinyl Sticker).

Colour Picker for Backgrounds & Borders

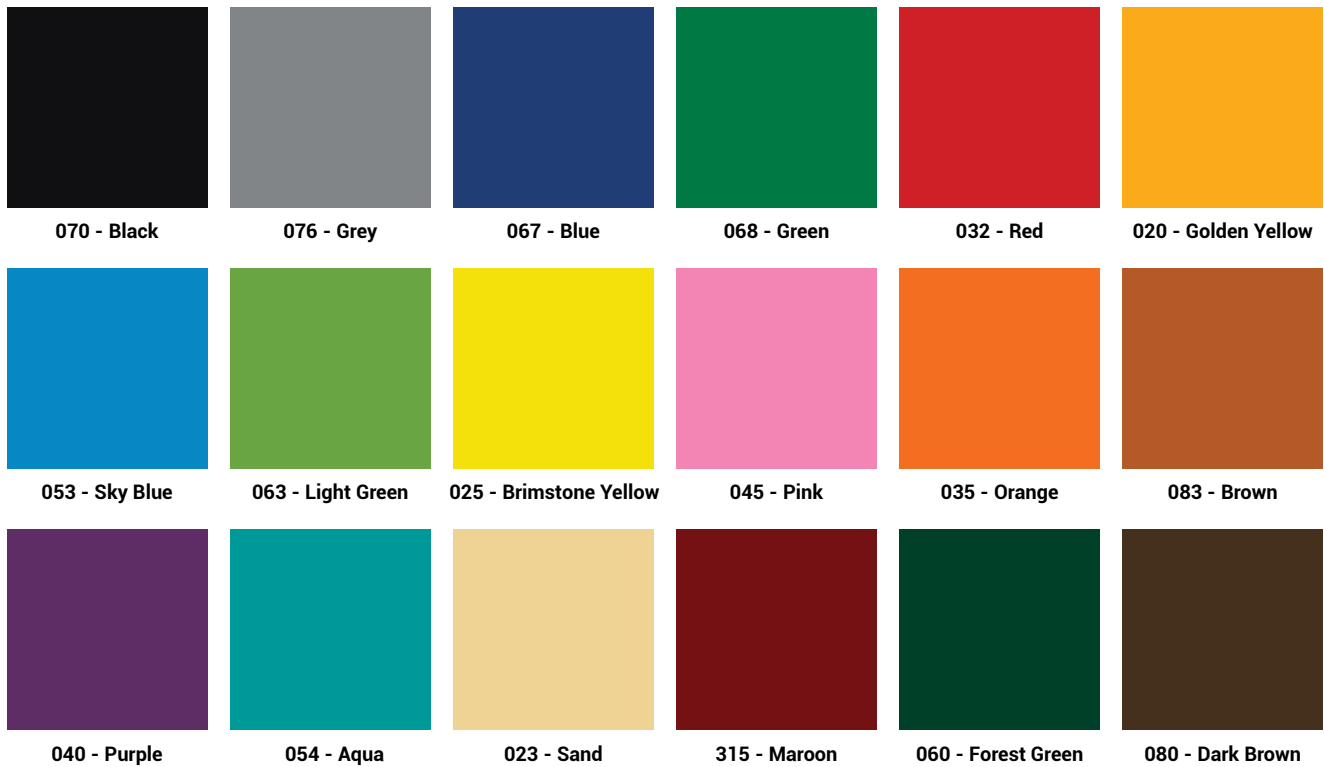

TO ORDER: When placing your order please reference the product code off the opposing page followed by the letter to designate Size and then the letter to designate Material. The Size and Material options are noted next to the templates on the opposite page. Then note the Text that you require on the sign and the Text, Border & Background Colour using the Colour Picker above.

For example the custom 300x400mm PVC sign to the right would be specified as follows;
VG7000BP - "This is an Example Custom Sign",
Text 032, Border 070, Background 025.



Please Note: Our default Font is Arial Black and Capitals so all text will be printed in this Font, converted to Uppercase and centered Horizontally & Vertically in the available space unless specifically requested otherwise. For alternative Fonts & Layouts please contact us via the contact details at the botton of this page.



VG7501



VG7503



VG7504



VG7526



VG7529



VG7530



VG7554



VG7555



VG7550



VG7527



VG7519



VG7521



VG7556



VG7560



VG7561



VG7563



VG7520



VG7562



VG7558



VG7505



VG7502



VG7506



VG7564



VG7567



VG7522



VG7523



VG7507



VG7559



VG7557



VG7565



VG7508



VG7524



VG7528



VG7566



VG7511



VG7533



VG7534



VG7549



VG7552



VG7553



VG7535



VG7536



VG7537



VG7538



VG7539

TO ORDER: When placing your order please reference the product code followed by one of the following letters to specify the size of the sign. H - 200 x 70mm, P - 400 x 150mm

Then add a second letter as follows to specify the material. A - ACM (4mm Aluminium Composite Material), P - PVC (2mm Rigid PVC Board), S - SAV (Self Adhesive Vinyl Sticker). For Example a 200 x 70mm PVC Sign code would look like VG7501HP



VG7540



VG7579

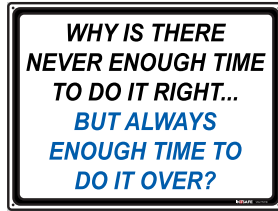

VG7578



VG7603



VG7604



VG7605



VG7545



VG7509



VG7510



VG7543



VG7541



VG7546



VG7516



VG7514



VG7512



VG7513



VG7515



VG7544



VG7547



VG7568



VG7569



VG7570



VG7571



VG7572



VG7573



VG7574



VG7575



VG7576



VG7577



VG7580

TO ORDER: When placing your order please reference the product code followed by one of the following letters to specify the size of the sign. A - 300 x 225 mm, B - 400 x 300mm, C - 600 x 450mm, D - 800 x 600mm

Then add a second letter as follows to specify the material. A - ACM (4mm Aluminium Composite Material), P - PVC (2mm Rigid PVC Board), S - SAV (Self Adhesive Vinyl Sticker). For Example a 400 x 300mm PVC Sign code would look like VG7546BP



VG7581



VG7582



VG7583



VG7584



VG7585



VG7586



VG7587



VG7588



VG7589



VG7590



VG7591



VG7592



VG7593



VG7594



VG7595



VG7596



VG7597



VG7598



VG7599



VG7600



VG7601



VG7602



VG7606



VG7607



VG7608



VG7609



VG7610



VG7611



VG7612



VG7613

TO ORDER: When placing your order please reference the product code followed by one of the following letters to specify the size of the sign. A - 300 x 225 mm, B - 400 x 300mm, C - 600 x 450mm, D - 800 x 600mm

Then add a second letter as follows to specify the material. A - ACM (4mm Aluminium Composite Material), P - PVC (2mm Rigid PVC Board), S - SAV (Self Adhesive Vinyl Sticker). For Example a 400 x 300mm PVC Sign code would look like VG7580BP



VG7001



VG7002



VG7003



VG7004



VG7005



VG7006



VG7780



VG7781



VG7782



VG7783



VG7784



VG7785



VG7786



VG7787



VG7788



VG7789



VG7790



VG7791

TO ORDER: When placing your order please reference the product code followed by one of the following letters to specify the size of the sign. A - 225 x 300mm, B - 300 x 400mm, C - 450 x 600mm, D - 600 x 800mm
Then add a second letter as follows to specify the material. A - ACM (4mm Aluminium Composite Material), P - PVC (2mm Rigid PVC Board), S - SAV (Self Adhesive Vinyl Sticker). For Example a 300 x 400mm PVC Sign code would look like VM7029BP



Hi Vis Vest with VISITOR Logo
PCV1507-FLYE - Yellow
PCV1507-FLOR - Orange

Available in the following Sizes
XXXS, XXS, XS, S - 6XL & 8XL



Hi Vis Hard Hat
with VISITOR Logo
VGHH100-FLYE - Yellow
VGHH100-BL - Blue
VGHH100-WH - White

Visitor Hard Hat Stickers also available
VHH7001



VG7627



VG7628



VG7629



VG7630



VG7631



VG7632



VG7633

TO ORDER: When placing an order reference the product code followed by the letter to specify the size of the sign. T - 450 x 200mm Then add a second letter as follows to specify the material. A - ACM (4mm Aluminium Composite Material), P - PVC (2mm Rigid PVC Board), S - SAV (Self Adhesive Vinyl Sticker). For Example a 450 x 200mm PVC Sign code would look like VG7530TP

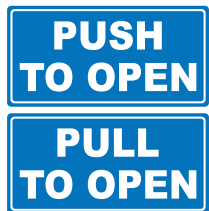

VG7700

2 Piece Sticker Set
Self Adhesive Vinyl
200x100mm

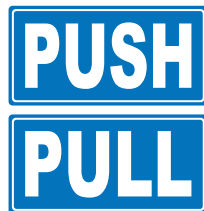

VG7701

2 Piece Sticker Set
Self Adhesive Vinyl
150x75mm

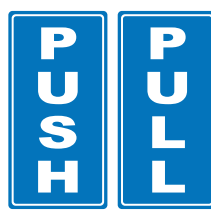

VG7702

2 Piece Sticker Set
Self Adhesive Vinyl
75x150mm

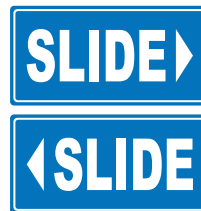

VG7703

2 Piece Sticker Set
Self Adhesive Vinyl
150x75mm



VG7705

3 Piece Sticker Set
Self Adhesive Vinyl
Reversed for Inside
Window Application
75x75mm



VW7007

Warning Sticker
Self Adhesive Vinyl
VW7007GS - 100x100mm
VW7007LS - 150x150mm
VW7007RS - 200x200mm
VW7007VS - 295x295mm



VG7750



VG7751



VG7752



VG7753



VG7754



VG7755



VG7756



VG7757

Stickers designed to avoid costly Refuelling & Servicing Mistakes. These are printed on a durable Outdoor Vinyl that will adhere well to any clean smooth surface especially designed for use on Heavy Machinery in the Construction & Forestry Industries.

TO ORDER: When placing your order please reference the product code followed by one of the following letters to specify the size of the sign. M - 20 x 150mm, A - 300 x 225mm, B - 400 x 300mm

Then add a second letter as follows to specify the material. A - ACM (4mm Aluminium Composite Material), P - PVC (2mm Rigid PVC Board), S - SAV (Self Adhesive Vinyl Sticker). For Example a 200 x 150mm SAV (Sticker) code would look like VG7750MS



VG7614



VG7615



VG7616



VG7617



VG7618



VG7619



VG7620



VG7621



VG7622



VG7623



VG7624



VG7625



VG7626

GENERAL SIGNS - RECYCLING

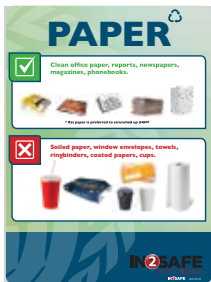

VG7010



VG7011

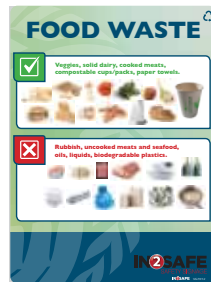

VG7012

TO ORDER: When placing your order please reference the product code followed by one of the following letters to specify the size of the sign. A - 225 x 300mm, B - 300 x 400mm, C - 450 x 600mm, D - 600 x 800mm

Then add a second letter as follows to specify the material. A - ACM (4mm Aluminium Composite Material), P - PVC (2mm Rigid PVC Board), S - SAV (Self Adhesive Vinyl Sticker). For Example a 300 x 400mm PVC Sign code would look like VG7010BP



VG7634



VG7635



VG7636



VG7637



VG7638

TO ORDER: When placing your order please reference the product code followed by one of the following letters to specify the size of the sign. A - 300 x 225 mm, B - 400 x 300mm, C - 600 x 450mm, D - 800 x 600mm

Then add a second letter as follows to specify the material. A - ACM (4mm Aluminium Composite Material), P - PVC (2mm Rigid PVC Board), S - SAV (Self Adhesive Vinyl Sticker). For Example a 400 x 300mm PVC Sign code would look like VG7624BP



VG7639



VG7640



VG7641



VG7642



VG7643



VG7644



VG7645



VG7646



VG7647



VG7648



VG7649



VG7650



VG7651



VG7652



VG7653



VG7654



VG7655

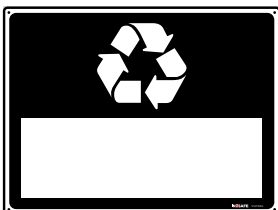

VG7656



VG7657



VG7658



VG7659



VG7660



VG7661



VG7662



VG7663



VG7664



VG7665

TO ORDER: When placing your order please reference the product code followed by one of the following letters to specify the size of the sign. A - 300 x 225 mm, B - 400 x 300mm, C - 600 x 450mm, D - 800 x 600mm

Then add a second letter as follows to specify the material. A - ACM (4mm Aluminium Composite Material), P - PVC (2mm Rigid PVC Board), S - SAV (Self Adhesive Vinyl Sticker). For Example a 400 x 300mm PVC Sign code would look like VG7658BP



VG7666



VG7667



VG7668



VG7669



VG7670



VG7671



VG7672



VG7673

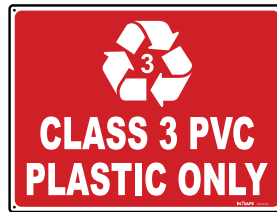

VG7674



VG7675



VG7676



VG7677



VG7678

TO ORDER: When placing your order please reference the product code followed by one of the following letters to specify the size of the sign. A - 300 x 225 mm, B - 400 x 300mm, C - 600 x 450mm, D - 800 x 600mm

Then add a second letter as follows to specify the material. A - ACM (4mm Aluminium Composite Material), P - PVC (2mm Rigid PVC Board), S - SAV (Self Adhesive Vinyl Sticker). For Example a 400 x 300mm PVC Sign code would look like VG7673BP



VC7525

When placing your order please reference the product code followed by one of the following letters to specify the size of the sign. C - 600 x 450mm, D - 800 x 600mm
Then add a second letter as follows to specify the material. A - ACM (4mm Aluminium Composite Material) P - PVC (2mm Rigid P Board), For Example a 800 x 600mm ACM Sign code would look like VC7525DA



VHB7015

Recycling Operations Site Hazard board

Designed to cover all Major Hazards these boards are 800x1200mm and are printed on HIP Reflective for maximum impact in an outdoor Multi-Hazard environment

Letters below are not shown at actual size

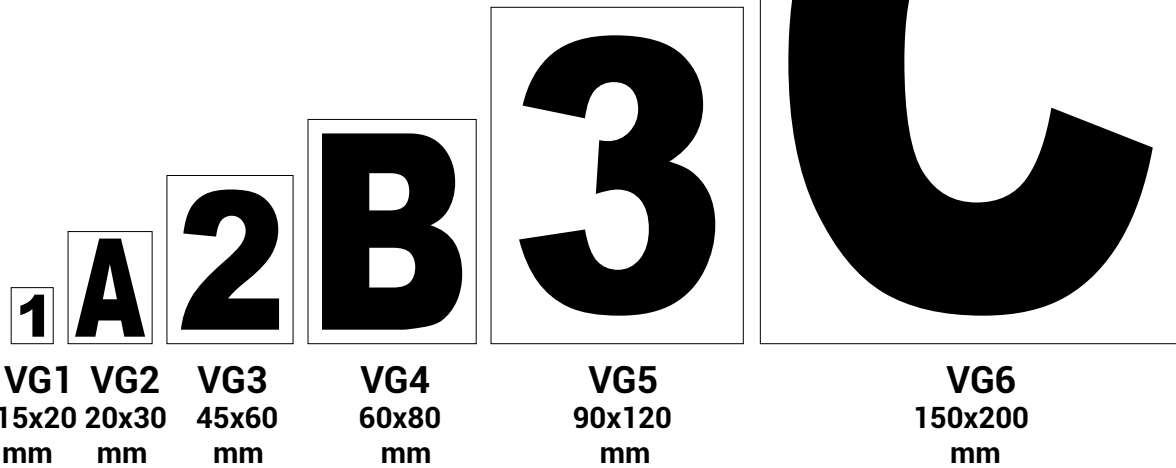

Colour Picker for Letters & Numbers

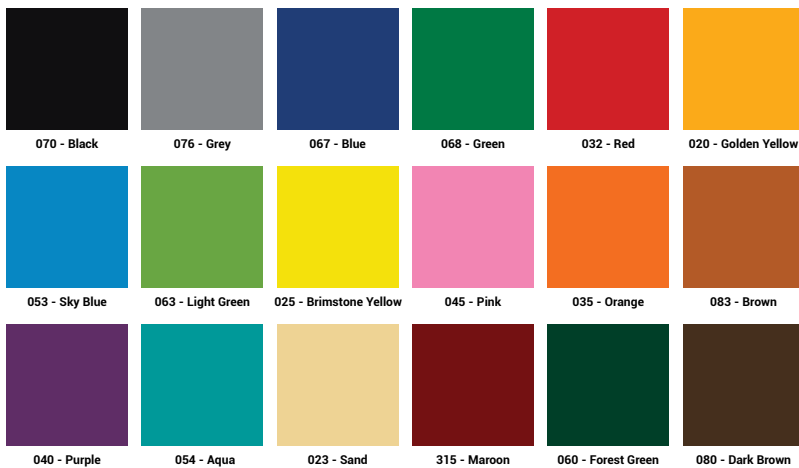

TO ORDER: When placing your order please reference the product code followed by one of the following letter Combinations to specify the Type of Material.

- A - ACM (4mm Aluminium Composite Material)
- P - PVC (2mm Rigid PVC Board)
- M- Magnetic (30MIL Automotive Grade Flexible Magnetic Material)
- SC - SAV - Clear (Clear Self Adhesive Vinyl Sticker)
- SW - SAV - White (White Self Adhesive Vinyl Sticker)
- CV - Cut Vinyl Lettering (Cut Self Adhesive Vinyl Sticker with no background material)

Then specify the Colour of the letters using the 3 Digit number from the Colour picker. Note the combination & Quantity of Letters & Numbers you require in Brackets.

For Example the code for 2 of Number 3 & 2 of Letter A in 90x120mm Red Cut Vinyl Lettering would look like VG5CV032(2x3, 2xA)

DANGER

LOGGING OPERATIONS HAZARDOUS AREA

<p>VISITORS DO NOT ENTER</p> <p>UNTIL ACKNOWLEDGED AND SIGNALLED TO PROCEED BY AUTHORISED STAFF</p>	<p>RESTRICTED TO AUTHORISED PERSONS</p> <p>ALL PERSONS ENTERING THIS SITE MUST COMPLY WITH THE SAFETY REGULATIONS OF THE HEALTH & SAFETY AT WORK ACT 2015</p>
<p>DANGER</p> <p>HI VIS HARD HATS & VESTS MUST BE WORN PAST THIS POINT</p>	<p>TRUCK DRIVERS</p> <p>ALL TRUCK DRIVERS MUST STAND IN THE SAFE ZONE DRIVERS MUST BE OUT OF THE CAB BEFORE LOADING WILL COMMENCE & DURING THE LOADING PROCESS</p>

ANY NON COMPLIANCE WITH THE ABOVE MAY RESULT IN YOUR IMMEDIATE REMOVAL FROM THIS SITE

IN2SAFE VHB7008 Your company details here! Your Logo Here!

VHB7008R (Drivers out of the Cab)
800x1200mm ACM Hazard Board
printed on HIP Reflective Material

DANGER

LOGGING OPERATIONS HAZARDOUS AREA

<p>VISITORS DO NOT ENTER</p> <p>UNTIL ACKNOWLEDGED AND SIGNALLED TO PROCEED BY AUTHORISED STAFF</p>	<p>RESTRICTED TO AUTHORISED PERSONS</p> <p>ALL PERSONS ENTERING THIS SITE MUST COMPLY WITH THE SAFETY REGULATIONS OF THE HEALTH & SAFETY AT WORK ACT 2015</p>
<p>DANGER</p> <p>HI VIS HARD HATS & VESTS MUST BE WORN PAST THIS POINT</p>	<p>TRUCK DRIVERS</p> <p>ALL TRUCK DRIVERS MUST BE IN THE CAB BEFORE LOADING WILL COMMENCE & DURING THE LOADING PROCESS</p>

ANY NON COMPLIANCE WITH THE ABOVE MAY RESULT IN YOUR IMMEDIATE REMOVAL FROM THIS SITE

IN2SAFE VHB7024 Your company details here! Your Logo Here!

VHB7024R (Drivers in the Cab)
800x1200mm ACM Hazard Board
printed on HIP Reflective Material

DANGER

TREE WORK OPERATION HAZARDOUS AREA

<p>VISITORS DO NOT ENTER</p> <p>PLEASE CONTACT BEFORE ENTRY</p> <p>PHONE OR RADIO</p> <p>NAME: _____</p> <p>CHANNEL/NUMBER BELOW: _____</p>	<p>RESTRICTED TO AUTHORISED PERSONS</p> <p>ALL PERSONS ENTERING THIS SITE MUST COMPLY WITH THE SAFETY REGULATIONS OF THE HEALTH & SAFETY IN EMPLOYMENT ACT 1992</p>
<p>SITE HAZARDS</p> <ul style="list-style-type: none"> MOVING MACHINERY FALLING TREES MOVING ROPES FLYING DEBRIS <p>THINK! AND START A TREND HERE</p>	<p>DANGER</p> <p>HI VIS HARD HATS, VESTS & SAFETY GLASSES MUST BE WORN PAST THIS POINT</p>

ANY NON COMPLIANCE WITH THE ABOVE MAY RESULT IN YOUR IMMEDIATE REMOVAL FROM THIS SITE

IN2SAFE VHB7013 Your company details here! Your Logo Here!

VHB7013R
800x1200mm ACM Hazard Board
printed on HIP Reflective Material

DANGER

LOGGING OPERATIONS HAZARDOUS AREA

<p>VISITORS DO NOT ENTER</p> <p>UNTIL ACKNOWLEDGED AND SIGNALLED TO PROCEED BY AUTHORISED STAFF</p>	<p>RESTRICTED TO AUTHORISED PERSONS</p> <p>ALL PERSONS ENTERING THIS SITE MUST COMPLY WITH THE SAFETY REGULATIONS OF THE HEALTH & SAFETY AT WORK ACT 2015</p>
<p>DANGER</p> <p>HI VIS HARD HATS & VESTS MUST BE WORN PAST THIS POINT</p>	<p>TRUCK DRIVERS</p> <p>ALL TRUCK DRIVERS MUST STAND IN THE SAFE ZONE DRIVERS MUST BE OUT OF THE CAB BEFORE LOADING WILL COMMENCE & DURING THE LOADING PROCESS</p>

GPS Co-Ordinates of this site are: _____

Emergency Contact Person: _____

All Contractors Must Sign in at _____

ANY NON COMPLIANCE WITH THE ABOVE MAY RESULT IN YOUR IMMEDIATE REMOVAL FROM THIS SITE

IN2SAFE VHB7026 Your company details here! Your Logo Here!

VHB7026R
800x1550mm ACM Hazard Board
printed on HIP Reflective Material

DANGER

**MINING OPERATIONS
HAZARDOUS AREA**

<p>VISITORS DO NOT ENTER</p> <p>UNTIL ACKNOWLEDGED AND SIGNALLED TO PROCEED BY AUTHORISED STAFF</p>	<p>RESTRICTED TO AUTHORISED PERSONS</p> <p>ALL PERSONS ENTERING THIS SITE MUST COMPLY WITH THE SAFETY REGULATIONS OF THE HEALTH & SAFETY AT WORK ACT 2015</p>
<p>DANGER</p> <p>HI VIS HARD HATS & VESTS MUST BE WORN PAST THIS POINT</p>	<p>TRUCK DRIVERS</p> <p>ALL TRUCK DRIVERS MUST STAND IN THE SAFE ZONE DRIVERS MUST BE OUT OF THE CAB BEFORE LOADING WILL COMMENCE & DURING THE LOADING PROCESS</p>

ANY NON COMPLIANCE WITH THE ABOVE MAY RESULT
IN YOUR IMMEDIATE REMOVAL FROM THIS SITE

IN2SAFE VHB7020 Your company details here! Your Logo Here!

VHB7020R
800x1200mm ACM Hazard Board
printed on HIP Reflective Material

DANGER

**HARVESTING OPERATIONS
HAZARDOUS AREA**

<p>VISITORS DO NOT ENTER</p> <p>UNTIL ACKNOWLEDGED AND SIGNALLED TO PROCEED BY AUTHORISED STAFF</p>	<p>RESTRICTED TO AUTHORISED PERSONS</p> <p>ALL PERSONS ENTERING THIS SITE MUST COMPLY WITH THE SAFETY REGULATIONS OF THE HEALTH & SAFETY AT WORK ACT 2015</p>
<p>DANGER</p> <p>HI VIS HARD HATS & VESTS MUST BE WORN PAST THIS POINT</p>	<p>TRUCK DRIVERS</p> <p>ALL TRUCK DRIVERS MUST STAND IN THE SAFE ZONE DRIVERS MUST BE OUT OF THE CAB BEFORE LOADING WILL COMMENCE & DURING THE LOADING PROCESS</p>

ANY NON COMPLIANCE WITH THE ABOVE MAY RESULT
IN YOUR IMMEDIATE REMOVAL FROM THIS SITE

IN2SAFE VHB7021 Your company details here! Your Logo Here!

VHB7021R
800x1200mm ACM Hazard Board
printed on HIP Reflective Material

DANGER

**QUARRY OPERATIONS
HAZARDOUS AREA**

<p>VISITORS DO NOT ENTER</p> <p>UNTIL ACKNOWLEDGED AND SIGNALLED TO PROCEED BY AUTHORISED STAFF</p>	<p>RESTRICTED TO AUTHORISED PERSONS</p> <p>ALL PERSONS ENTERING THIS SITE MUST COMPLY WITH THE SAFETY REGULATIONS OF THE HEALTH & SAFETY AT WORK ACT 2015</p>
<p>DANGER</p> <p>HI VIS HARD HATS & VESTS MUST BE WORN PAST THIS POINT</p>	<p>TRUCK DRIVERS</p> <p>ALL TRUCK DRIVERS MUST STAND IN THE SAFE ZONE DRIVERS MUST BE OUT OF THE CAB BEFORE LOADING WILL COMMENCE & DURING THE LOADING PROCESS</p>

ANY NON COMPLIANCE WITH THE ABOVE MAY RESULT
IN YOUR IMMEDIATE REMOVAL FROM THIS SITE

IN2SAFE VHB7014 Your company details here! Your Logo Here!

VHB7014R
800x1200mm ACM Hazard Board
printed on HIP Reflective Material

DANGER

**RECYCLING OPERATIONS
HAZARDOUS AREA**

<p>VISITORS DO NOT ENTER</p> <p>UNTIL ACKNOWLEDGED AND SIGNALLED TO PROCEED BY AUTHORISED STAFF</p>	<p>RESTRICTED TO AUTHORISED PERSONS</p> <p>ALL PERSONS ENTERING THIS SITE MUST COMPLY WITH THE SAFETY REGULATIONS OF THE HEALTH & SAFETY AT WORK ACT 2015</p>
<p>DANGER</p> <p>HI VIS HARD HATS & VESTS MUST BE WORN PAST THIS POINT</p>	<p>TRUCK DRIVERS</p> <p>ALL TRUCK DRIVERS MUST STAND IN THE SAFE ZONE DRIVERS MUST BE OUT OF THE CAB BEFORE LOADING WILL COMMENCE & DURING THE LOADING PROCESS</p>

ANY NON COMPLIANCE WITH THE ABOVE MAY RESULT
IN YOUR IMMEDIATE REMOVAL FROM THIS SITE

IN2SAFE VHB7015 Your company details here! Your Logo Here!

VHB7015R
800x1200mm ACM Hazard Board
printed on HIP Reflective Material

DANGER

**CONSTRUCTION SITE
HAZARDOUS AREA**

**VISITORS
DO NOT ENTER**

**RESTRICTED TO
AUTHORISED PERSONS**
ALL PERSONS ENTERING THIS SITE
MUST COMPLY WITH THE SAFETY
REGULATIONS OF THE HEALTH &
SAFETY AT WORK ACT 2015

DANGER
**HI VIS
HARD HATS
& VESTS
MUST BE WORN
PAST THIS
POINT**

TRUCK DRIVERS
ALL TRUCK DRIVERS
MUST STAND IN THE
SAFE ZONE
DRIVERS MUST BE OUT OF
THE CAB BEFORE LOADING
WILL COMMENCE & DURING
THE LOADING PROCESS

**ANY NON COMPLIANCE WITH THE ABOVE MAY RESULT
IN YOUR IMMEDIATE REMOVAL FROM THIS SITE**

IN2SAFE
VHB7022

Your company details here!

Your Logo
Here!

DANGER

**CONSTRUCTION SITE
No Unauthorised Access**

ALL VISITORS MUST REPORT TO SITE OFFICE

Name:

Phone:

Name:

Phone:

TO WORK ON THIS SITE YOU MUST HAVE:

Hard Hat

Safety Footwear

High Visibility Vest

Other PPE as Appropriate

Tagged Electrical Cords

A TIDY SITE IS A SAFE SITE

IN2SAFE
VHB7013

Your company details here!

Your Logo
Here!

VHB7022R
800x1200mm ACM Hazard Board
printed on HIP Reflective Material

VHB7018R
800x1200mm ACM Hazard Board
printed on HIP Reflective Material

Your Logo
Here

CONSTRUCTION SITE
AUTHORISED PERSONNEL ONLY

When entering this site you must comply with the Health & Safety at Work Act 2015

DANGER

NOTICE
**ALL VISITORS
MUST REPORT TO
SITE OFFICE UPON
ARRIVAL**

SITE HAZARDS

Hazard	Controls	
Visitors / Contractors		<input checked="" type="checkbox"/>
Trips / Slips		<input type="checkbox"/>
Electricity in Use		<input type="checkbox"/>
Ladders		<input type="checkbox"/>
Power & Hand Tools		<input type="checkbox"/>
Noise		<input type="checkbox"/>
Excavations		<input type="checkbox"/>
Vehicles / Heavy Machinery		<input type="checkbox"/>
Scaffold/ Work Platforms		<input type="checkbox"/>
Fall From Height		<input type="checkbox"/>
Overhead Work		<input type="checkbox"/>
		<input type="checkbox"/>
		<input type="checkbox"/>

SITE DETAILS

Site Address: _____
 Site Supervisor: _____
 Site Supervisor Mobile: _____
 Office Phone: _____

PPE TO BE WORN ONSITE

EVACUATION PLAN

In the event of an accident or emergency:

- Follow Site Supervisor's instructions
- Call 111
- Make site safe, shut down equipment
- Provide first aid
- Evacuate work site if required and go to the assembly point

Assembly Point: _____
 First Aid Kit Here: _____

VHB7025
600x800mm ACM Hazard Board



VD7003



VH7001

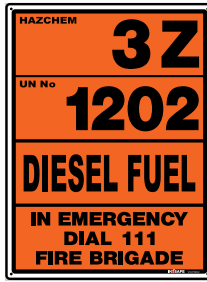

VH7002

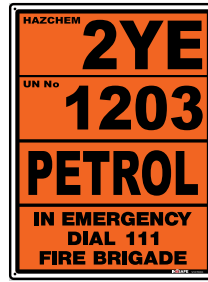

VH7003



VH7004

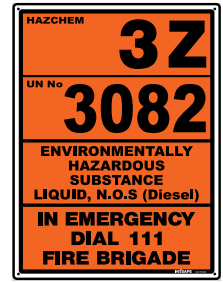

VH7005



VH7006



VH7007

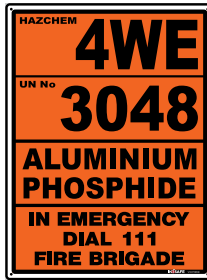

VH7008

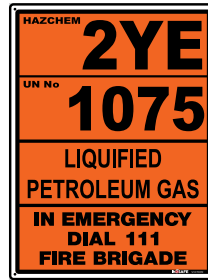

VH7009



VH7010

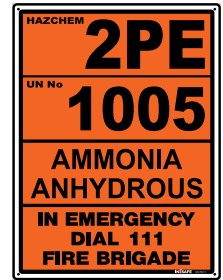

VH7011



VH7012

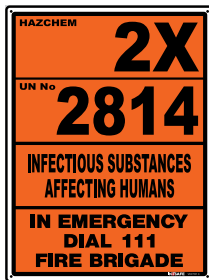

VH7013



VH7015



VH7000

TO ORDER CUSTOM EMERGENCY INFORMATION PANELS :

When placing your order please reference the product code VH7000, followed by the letter to designate Size and then the letter to designate Material as explained in the Footer below. Then specify the Hazchem Code, UN Number and Chemical Name you require.

For example a custom 400x300mm PVC sign for Hydrochloric Acid would be specified in the following manner; VH7000BP, "2R, UN 1789, HYDROCHLORIC ACID"

TO ORDER: When placing your order please reference the product code followed by one of the following letters to specify the size of the sign. A - 225 x 300mm, B - 300 x 400mm, C - 450 x 600mm, D - 600 x 800mm

Then add a second letter as follows to specify the material. A - ACM (4mm Aluminium Composite Material), P - PVC (2mm Rigid PVC Board), S - SAV (Self Adhesive Vinyl Sticker). For Example a 300 x 400mm PVC Sign code would look like VH7015BP



VH7201



VH7223



VH7206



VH7218



VH7211



VH7246



VH7227



VH7212



VH7219



VH7210



VH7224



VH7209



VH7208



VH7233



VH7207



VH7213



VH7214



VH7241



VH7235



VH7202



VH7234



VH7232



VH7244



VH7203



VH7205



VH7237



VH7204



VH7238



VH7226



VH7239



VH7240



VH7236



VH7215



VH7222



VH7243



VH7228



For Steel Holder to suit 295x295mm DG signage see page 46 VH7500G

TO ORDER: When placing your order please reference the product code followed by one of the following letters to specify the size of the sign. O - 75x75mm, G - 100x100mm, L - 150x150mm, R - 200x200mm, U - 250x250mm, V - 295x295mm, W - 400x400mm. Then add a second letter as follows to specify the material. A - ACM (4mm Aluminium Composite Material), P - PVC (2mm Rigid PVC Board), S - SAV (Self Adhesive Vinyl Sticker). For Example a 295 x 295mm PVC Sign code would look like VH7212VP

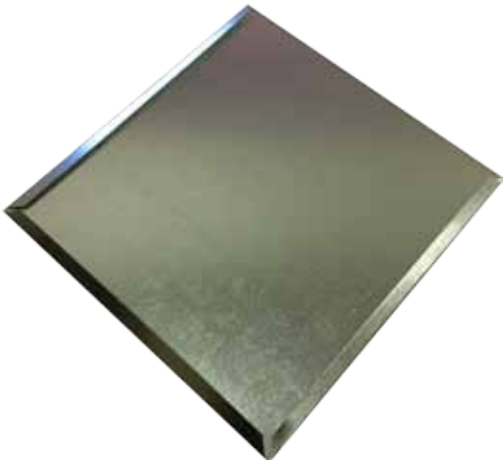

VH7500G



VH7505

IN2SAFE

Dangerous Goods Declaration					
Declaration No. (To be filled in by the shipper) _____ Date of Declaration (DD/MM/YYYY) _____					
Shipper/Consignor (Name & Address) Telephone No. _____ Fax No. _____			Addressee Job/Order No. _____ Contact Officer _____ Telephone No. _____ Fax No. _____		
UN Number (See Schedule 1)	Quantity or Volume	Proper Shipping Name	Packing Group	Quantity/Type of Package	Gross Mass (kg / L)
Additional Information: _____					
Emergency Telephone No. _____ (0800 111 Emergency Services)					
Notes: 1. Make the sign legible from inside the vehicle. Use reflective material on the vehicle. Mark the vehicle base of the pack, container and pallet markings as provided on the back of the declaration. 2. Declaration must be made in duplicate on the declaration form and one copy must be placed in each of the packages. 3. Make a copy of the declaration and retain it for at least 30 days after the date of the declaration.					
Declaration: I hereby declare that the information contained in this document is true and that the contents of this container are correctly packed and meet all the requirements of the New Zealand Rules. I accept full responsibility for the information provided and for the safety of the goods.			Signature: _____ Date: _____ Signature: _____		
IN AN EMERGENCY DIAL 111 - FIRE OR POLICE 1. Make the vehicle safe and secure. Do not. Return the document to the vehicle and follow any written instructions. 2. Notify the police and fire services immediately. Make 111 calls. 3. Contact shipping agent for any further information. Do not transport until instructed. 4. Contact shipping agent for any further information. Do not transport until instructed. 5. Make a copy of the declaration and retain it for at least 30 days after the date of the declaration.					

VH7510

Emergency Response Information

UN Number	Proper shipping name	Class	Packing Group
UN 3082	ENVIRONMENTALLY HAZARDOUS SUBSTANCE, LIQUID, N.O.S. (Diesel)	9	III

In an emergency:

- Show to your distance from the incident, at least 15 metres if diesel is spilled. Call emergency response information and call phone with you.
- Call 111 and ask for Police or Fire Service.
- Tell them where the incident has happened and any details of injuries.
- Tell them that dangerous goods are involved and advise the UN number, proper shipping name and class of the dangerous goods, as written at the top of this page.
- When the police and keep them clear of the incident.
- Move yourself and to higher ground.
- Follow the instructions of the Police or Fire Service.

VH7300 UN3082 Emergency Response Information Card

UN 3082
ENVIRONMENTALLY
HAZARDOUS SUBSTANCE,
LIQUID, N.O.S. (Diesel)

UN1203
FLAMMABLE LIQUID
PETROL (3YE)

HAZCHEM
3Z UN No. 3082
ENVIRONMENTALLY
HAZARDOUS SUBSTANCE,
LIQUID, N.O.S (DIESEL)

PROTECT
WATERWAYS
ENSURE DRAINS
ARE CLOSED

KEEP AWAY FROM
IGNITION SOURCES

NO SMOKING
NO NAKED FLAMES

IN EMERGENCY
DIAL 111
FIRE, POLICE OR
AMBULANCE

VH7307 - Stationery Farm Diesel Tank Sticker Over 1000L

HAZCHEM
3YE UN No. 1203
PETROL

PROTECT
WATERWAYS
ENSURE DRAINS
ARE CLOSED

KEEP AWAY FROM
IGNITION SOURCES

NO SMOKING
NO NAKED FLAMES

IN EMERGENCY
DIAL 111
FIRE, POLICE OR
AMBULANCE

VH7308 - Stationery Farm Petrol Tank Sticker Over 250L

Diesel Container 5-24L VH7301 - SAV Sticker VH7301T - PVC Tag

Petrol Container 5-24L VH7305 - SAV Sticker VH7305T - PVC Tag

UN 3082, ENVIRONMENTALLY
HAZARDOUS SUBSTANCE,
LIQUID, N.O.S. (Diesel)

UN 3082, ENVIRONMENTALLY
HAZARDOUS SUBSTANCE,
LIQUID, N.O.S. (Diesel)

VH7302 Diesel Tank Sticker - Ute Tanks

VH7303 Mobile Diesel Tank Sticker 25-450L

Ute Tanks & Trailer Tanks 25-450L require two of the above stickers, one on each side of the Tank

HAZCHEM 3Z UN3082
ENVIRONMENTALLY HAZARDOUS SUBSTANCE, LIQUID, N.O.S (DIESEL)

ECOTOXIC TO AQUATIC LIFE, PROTECT
WATERWAYS, ENSURE DRAINS ARE CLOSED

IN EMERGENCY DIAL 111 FIRE BRIGADE

VH7304 Trailer Diesel Tank Sticker 450-2000L Each Tank requires 3 of these stickers & 1x VH7206 Misc Dangerous Goods DG label at 400x400mm

HAZCHEM
3Z UN3082
ENVIRONMENTALLY
HAZARDOUS SUBSTANCE,
LIQUID, N.O.S
(DIESEL)

IN EMERGENCY
DIAL 111
FIRE BRIGADE

ECOTOXIC TO AQUATIC LIFE,
PROTECT WATERWAYS,
ENSURE DRAINS ARE CLOSED

VH7306 Trailer Diesel Tank Sticker Over 2000L Each Tank requires 3 of these stickers & 1x VH7206 Misc Dangerous Goods DG label at 400x400mm

HAZCHEM
3[Z] UN No. 1202
DIESEL

ECOTOXIC TO AQUATIC LIFE
PROTECT WATERWAYS,
ENSURE DRAINS ARE CLOSED

IN EMERGENCY DIAL 111 FIRE, POLICE OR AMBULANCE
24HR COMPANY CONTACT.....
REGIONAL COUNCIL POLLUTION RESPONSE SERVICE.....

VH7309 - Stationary Diesel Tank 1000-10000 Litres Capacity



VH7800



VH7801



VH7802



VH7807



VH7820



VH7821



VH7803



VH7804



VH7805



VH7806



VH7822

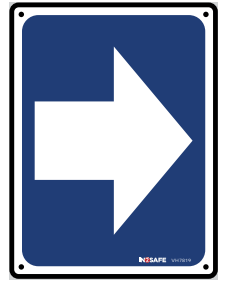

VH7819



VH7808



VH7809



VH7810



VH7811



VH7813



VH7823



VH7816



VH7824



VH7817



VH7825



VH7826



VH7827



VH7828



VH7829



VH7830



VH7831



VH7832

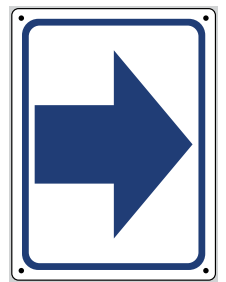

VH7833

TO ORDER: When placing your order please reference the product code followed by one of the following letters to specify the size of the sign. M - 150 x 200mm, A - 225 x 300mm, B - 300 x 400mm, C - 450 x 600mm
Then add a second letter as follows to specify the material. A - ACM (4mm Aluminium Composite Material), P - PVC (2mm Rigid PVC Board), S - SAV (Self Adhesive Vinyl Sticker). For Example a 150 x 200mm PVC Sign code would look like VH7806MP



VH7812



VH7814



VH7815



VH7834



VH7835



VH7836



VH7837



VH7838



VH7839



VH7840



VH7841



VH7842



VH7843



VH7844



VH7845



VH7846



VH7847



VH7848

TO ORDER: When placing your order please reference the product code followed by one of the following letters to specify the size of the sign. O - 75 x 75mm, G - 100 x 100mm, L - 150 x 150mm, R - 200 x 200mm, Z - 300 x 300mm, W - 400 x 400mm
Then add a second letter as follows to specify the material. A - ACM (4mm Aluminium Composite Material), P - PVC (2mm Rigid PVC Board), S - SAV (Self Adhesive Vinyl Sticker). For Example a 100 x 100mm PVC Sign code would look like VH7812GP



VH7850



VH7818



VH7851



VH7852

TO ORDER: When placing your order please reference the product code followed by one of the following letters to specify the size of the sign. A - 300 x 225 mm, B - 400 x 300mm
Then add a second letter as follows to specify the material. A - ACM (4mm Aluminium Composite Material), P - PVC (2mm Rigid PVC Board), S - SAV (Self Adhesive Vinyl Sticker). For Example a 300 x 400mm PVC Sign code would look like VH7850BP

TO ORDER: When placing your order please reference the product code followed by one of the following letters to specify the size of the sign. N - 150 x 300mm, S - 200 x 400mm, J - 300 x 600mm
Then add a second letter as follows to specify the material. A - ACM (4mm Aluminium Composite Material), P - PVC (2mm Rigid PVC Board), S - SAV (Self Adhesive Vinyl Sticker). For Example a 200 x 400mm PVC Sign code would look like VH7851SP



VM7001



VM7002



VM7003



VM7004



VM7005



VM7006



VM7007



VM7008



VM7009



VM7010



VM7011



VM7012



VM7013



VM7014



VM7015



VM7016



VM7017



VM7018



VM7019



VM7020



VM7021



VM7022

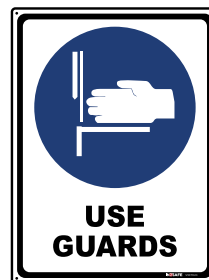

VM7023



VM7024



VM7025



VM7026

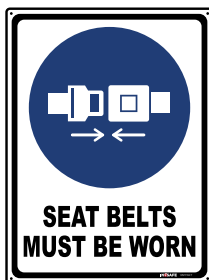

VM7027



VM7028



VM7029



VM7030

TO ORDER: When placing your order please reference the product code followed by one of the following letters to specify the size of the sign. A - 225 x 300mm, B - 300 x 400mm, C - 450 x 600mm, D - 600 x 800mm

Then add a second letter as follows to specify the material. A - ACM (4mm Aluminium Composite Material), P - PVC (2mm Rigid PVC Board), S - SAV (Self Adhesive Vinyl Sticker). For Example a 300 x 400mm PVC Sign code would look like VM7029BP



VM7031



VM7032



VM7033



VM7034



VM7035



VM7036



VM7037



VM7038



VM7039



VM7040



VM7041



VM7042



VM7043



VM7044



VM7045



VM7046



VM7047



VM7048

TO ORDER: When placing your order please reference the product code followed by one of the following letters to specify the size of the sign. A - 225 x 300mm, B - 300 x 400mm, C - 450 x 600mm, D - 600 x 800mm

Then add a second letter as follows to specify the material. A - ACM (4mm Aluminium Composite Material), P - PVC (2mm Rigid PVC Board), S - SAV (Self Adhesive Vinyl Sticker). For Example a 300 x 400mm PVC Sign code would look like VM7038BP



VM7501

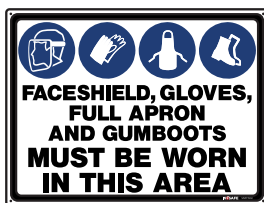

VM7502



VM7503



VM7506



VM7508



VM7510



VM7513



VM7514



VM7515



VM7516

TO ORDER: When placing your order please reference the product code followed by one of the following letters to specify the size of the sign. A - 300 x 225 mm, B - 400 x 300mm, C - 600 x 450mm, D - 800 x 600mm

Then add a second letter as follows to specify the material. A - ACM (4mm Aluminium Composite Material), P - PVC (2mm Rigid PVC Board), S - SAV (Self Adhesive Vinyl Sticker). For Example a 400 x 300mm PVC Sign code would look like VM7506BP



VM7504



VM7505



VM7509



VM7511



VM7512



VM7517



VM7518



VM7519



VM7520



VM7521



VM7522



VM7523



VM7524



VM7525



VM7526

TO ORDER: When placing an order reference the product code followed by the letter to specify the size of the sign. T - 450 x 200mm
Then add a second letter as follows to specify the material. A - ACM (4mm Aluminium Composite Material), P - PVC (2mm Rigid PVC Board), S - SAV (Self Adhesive Vinyl Sticker). For Example a 450 x 200mm PVC Sign code would look like VG7530TP



VN7547



VN7548



VN7504



VN7554



VN7558



VN7515



VN7551



VN7550



VN7535



VN7552



VN7510



VN7556



VN7557



VN7534



VN7549



VN7553



VN7505



VN7542



VN7555



VN7506



VN7511



VN7507



VN7509



VN7512



VN7513



VN7519



VN7522



VN7523



VN7529



VN7560

TO ORDER: When placing your order please reference the product code followed by one of the following letters to specify the size of the sign. A - 225 x 300mm, B - 300 x 400mm, C - 450 x 600mm, D - 600 x 800mm

Then add a second letter as follows to specify the material. A - ACM (4mm Aluminium Composite Material), P - PVC (2mm Rigid PVC Board), S - SAV (Self Adhesive Vinyl Sticker). For Example a 300 x 400mm PVC Sign code would look like VM7029BP



VN7563



VN7565



VN7567



VN7502



VN7533



VN7540



VN7568



VN7537



VN7538



VN7539



VN7501



VN7545



VN7528



VN7541



VN7525



VN7508



VN7514



VN7531



VN7544



VN7546



VN7503



VN7536



VN7561



VN7564



VN7530



VN7526



VN7562



VN7532



VN7559



VN7543

TO ORDER: When placing your order please reference the product code followed by one of the following letters to specify the size of the sign. A - 225 x 300mm, B - 300 x 400mm, C - 450 x 600mm, D - 600 x 800mm

Then add a second letter as follows to specify the material. A - ACM (4mm Aluminium Composite Material), P - PVC (2mm Rigid PVC Board), S - SAV (Self Adhesive Vinyl Sticker). For Example a 300 x 400mm PVC Sign code would look like VM7029BP



VF7549



VP7001



VP7002



VP7016



VP7024



VD7003



VD7005



VF7009



VP7003



VP7025



VP7059



VP7055



VP7007



VP7005



VP7006



VP7010



VP7011



VP7015



VP7019



VP7023



VP7060



VP7018



VP7020



VP7026



VP7031



VP7039



VP7046



VP7047



VP7048



VP7049

TO ORDER: When placing your order please reference the product code followed by one of the following letters to specify the size of the sign. A - 225 x 300mm, B - 300 x 400mm, C - 450 x 600mm, D - 600 x 800mm

Then add a second letter as follows to specify the material. A - ACM (4mm Aluminium Composite Material), P - PVC (2mm Rigid PVC Board), S - SAV (Self Adhesive Vinyl Sticker). For Example a 300 x 400mm PVC Sign code would look like VP7007BP



VP7040



VP7041



VP7042



VP7043



VP7044



VP7045



VP7014



VP7029



VP7036



VP7037



VP7038



VP7057



VP7004



VP7022



VP7030



VP7032



VP7054



VP7056



VP7008



VP7009



VP7034



VP7035



VP7058



VP7013



VP7021



VP7027



VP7028



VP7050



VP7051



VP7052

TO ORDER: When placing your order please reference the product code followed by one of the following letters to specify the size of the sign. A - 225 x 300mm, B - 300 x 400mm, C - 450 x 600mm, D - 600 x 800mm

Then add a second letter as follows to specify the material. A - ACM (4mm Aluminium Composite Material), P - PVC (2mm Rigid PVC Board), S - SAV (Self Adhesive Vinyl Sticker). For Example a 300 x 400mm PVC Sign code would look like VP7028BP



VP7501



VP7502



VP7503



VP7504



VP7505



VP7506



VP7507



VP7508



VP7510



VP7511

TO ORDER: When placing an order reference the product code followed by the letter to specify the size of the sign. T - 450 x 200mm Then add a second letter as follows to specify the material. A - ACM (4mm Aluminium Composite Material), P - PVC (2mm Rigid PVC Board), S - SAV (Self Adhesive Vinyl Sticker). For Example a 450 x 200mm PVC Sign code would look like VP7503TP



VD7590



VD7588



VD7595



VD7511



VD7578



VD7579



VP7512



VP7513



VP7514

TO ORDER: When placing your order please reference the product code followed by one of the following letters to specify the size of the sign.

M - 200 x 150mm, A - 300 x 225mm, B - 400 x 300mm, C - 600 x 450mm Then add a second letter as follows to specify the material. A - ACM (4mm Aluminium Composite Material), P - PVC (2mm Rigid PVC Board), S - SAV (Self Adhesive Vinyl Sticker). For Example a 400 x 300mm PVC Sign code would look like VP7512BP



VP7033IS

Self Adhesive Vinyl Reversed for Inside Window Application 75x75mm



VP7017



VP7033



VP7053

TO ORDER: When placing your order please reference the product code followed by one of the following letters to specify the size of the sign. O - 75 x 75mm, G - 100 x 100mm, L - 150 x 150mm, R - 200 x 200mm, Z - 300 x 300mm, W - 400 x 400mm

Then add a second letter as follows to specify the material. A - ACM (4mm Aluminium Composite Material), P - PVC (2mm Rigid PVC Board), S - SAV (Self Adhesive Vinyl Sticker). For Example a 100 x 100mm PVC Sign code would look like VP7017GP



VS7001



VS7002



VS7003



VS7004



VS7005



VS7006



VS7007



VS7008



VS7009



VS7010



VS7011

TO ORDER: When placing your order please reference the product code followed by one of the following letters to specify the size of the sign. A - 225 x 300mm, B - 300 x 400mm, C - 450 x 600mm, D - 600 x 800mm

Then add a second letter as follows to specify the material. A - ACM (4mm Aluminium Composite Material), P - PVC (2mm Rigid PVC Board), S - SAV (Self Adhesive Vinyl Sticker). For Example a 300 x 400mm PVC Sign code would look like VS7005BP



VS7201



VS7202



VS7204



VS7206



VS7207



VS7208



VS7209



VS7210



VS7211



VS7212

TO ORDER: When placing your order please reference the product code followed by one of the following letters to specify the size of the sign. M - 200 x 150mm, A - 300 x 225mm, B - 400 x 300mm, C - 600 x 450mm

Then add a second letter as follows to specify the material. A - ACM (4mm Aluminium Composite Material), P - PVC (2mm Rigid PVC Board), S - SAV (Self Adhesive Vinyl Sticker). For Example a 400 x 300mm PVC Sign code would look like VP7512BP



VT7001



VT7002



VT7003



VT7004



VT7005



VT7006



VT7054



VT7007



VT7055



VT7056



VT7057



VT7058



VT7037



VT7061



VT7062



VT7063

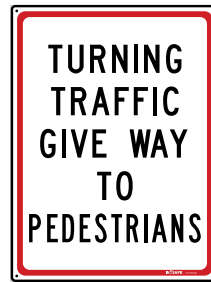

VT7035



VT7046



VT7020

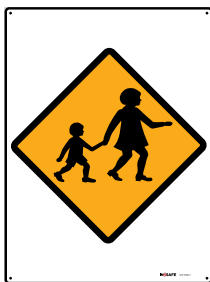

VT7021



VT7022



VT7049



VT7050



VT7048



VT7008



VT7009

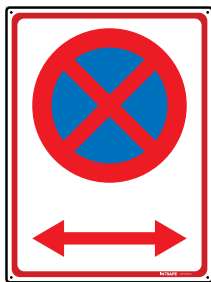

VT7074

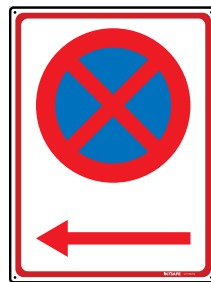

VT7075

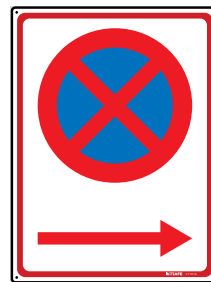

VT7076



VT7051

TO ORDER: When placing your order please reference the product code followed by one of the following letters to specify the size of the sign. A - 225 x 300mm, B - 300 x 400mm, C - 450 x 600mm, D - 600 x 800mm

Then add a second letter as follows to specify the material. A - ACM (4mm Aluminium Composite Material), P - PVC (2mm Rigid PVC Board), S - SAV (Self Adhesive Vinyl Sticker). For Example a 300 x 400mm PVC Sign code would look like VT7001BP



VT7011



VT7016



VT7017



VT7018



VT7019



VT7026



VT7027



VT7036



VT7040



VT7052



VT7028



VT7029



VT7077



VT7012



VT7024



VT7025



VT7047



VT7078



VT7079



VT7080



VT7081



VT7082



VT7083



VT7084



VT7085



VT7010



VT7013



VT7038



VT7041



VT7053

TO ORDER: When placing your order please reference the product code followed by one of the following letters to specify the size of the sign. A - 225 x 300mm, B - 300 x 400mm, C - 450 x 600mm, D - 600 x 800mm

Then add a second letter as follows to specify the material. A - ACM (4mm Aluminium Composite Material), P - PVC (2mm Rigid PVC Board), S - SAV (Self Adhesive Vinyl Sticker). For Example a 300 x 400mm PVC Sign code would look like VT7010BP



VT7044



VT7045



VT7042



VT7043



VT7014



VT7015



VT7023



VT7039

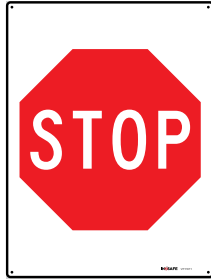

VT7071



VT7072

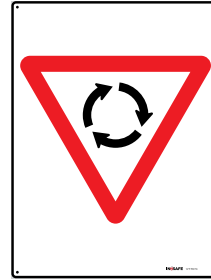

VT7073



VT7033



VT7034

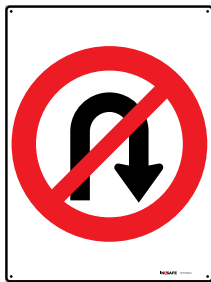

VT7032

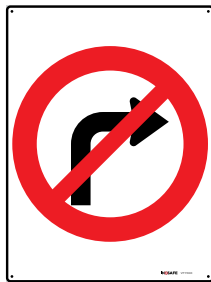

VT7030

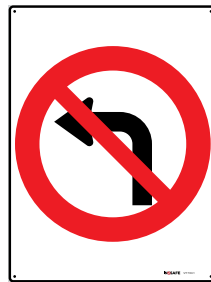

VT7031



VT7060



VT7059



VT7070

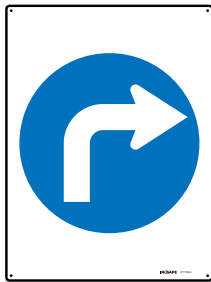

VT7064

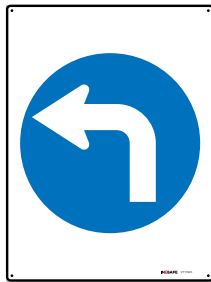

VT7065

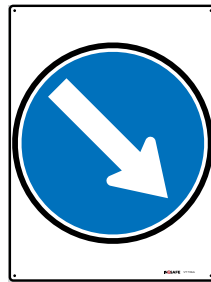

VT7066

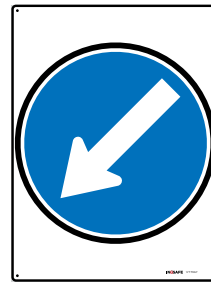

VT7067

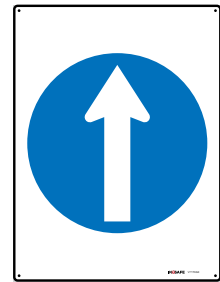

VT7068

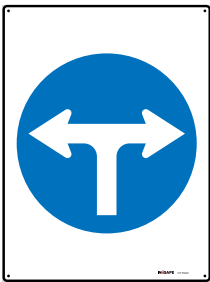

VT7069

TO ORDER: When placing your order please reference the product code followed by one of the following letters to specify the size of the sign. A - 225 x 300mm, B - 300 x 400mm, C - 450 x 600mm, D - 600 x 800mm

Then add a second letter as follows to specify the material. A - ACM (4mm Aluminium Composite Material), P - PVC (2mm Rigid PVC Board), S - SAV (Self Adhesive Vinyl Sticker). For Example a 300 x 400mm PVC Sign code would look like VT7071BP





VW7001



VW7002



VW7003



VW7004



VW7005



VW7006



VW7008



VW7009



VW7010



VW7011



VW7012



VW7013



VW7014



VW7015



VW7016



VW7017



VW7021



VW7022



VW7023



VW7007



VW7018



VW7019



VW7020



VW7024

TO ORDER: When placing your order please reference the product code followed by one of the following letters to specify the size of the sign. A - 225 x 300mm, B - 300 x 400mm, C - 450 x 600mm, D - 600 x 800mm

Then add a second letter as follows to specify the material. A - ACM (4mm Aluminium Composite Material), P - PVC (2mm Rigid PVC Board), S - SAV (Self Adhesive Vinyl Sticker). For Example a 300 x 400mm PVC Sign code would look like VT7010BP



VW7503



VW7504



VW7505



VW7506



VW7507



VW7508



VW7509



VW7510



VW7511



VW7512



VW7513



VW7514



VW7515



VW7516



VW7517

TO ORDER: When placing your order please reference the product code followed by one of the following letters to specify the size of the sign. A - 300 x 225 mm, B - 400 x 300mm, C - 600 x 450mm, D - 800 x 600mm

Then add a second letter as follows to specify the material. A - ACM (4mm Aluminium Composite Material), P - PVC (2mm Rigid PVC Board), S - SAV (Self Adhesive Vinyl Sticker). For Example a 400 x 300mm PVC Sign code would look like VG7580BP



VT7770K



VT7777K



VT7779K



VT7781K



VT7775K



VT7753K



VT7784K



VT7701K



VT7702K



VT7705K



VT7706K



VT7711K

TO ORDER: When placing your order please reference the product code followed the following suffix to specify the Material of the Sign. A - ACM (Aluminium Composite Material), A2 - 2mm Aluminium . For Example an ACM sign code would look like VT7770KA2
 Note: All these kits comprise two signs, 750x750mm Main & 950x500mm Supplementary signs. Drilled to suit Traffic Sign Stands.

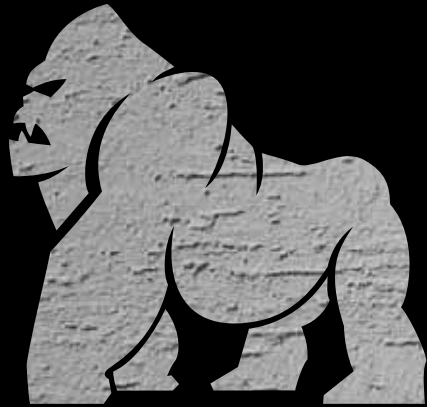
KONGCRETE®
POST INSTALLATION KIT
EASIER//QUICKER//LIGHTER THAN CONCRETE

IT'S AS EASY AS...



1 MIX 2 POUR 3 SET

KONGCRETE® is a revolutionary new way to install Sign & Fence posts. It is an alternative to concrete that is lightweight, does not require water, sets in 3 minutes and is extremely easy to use!

Each kit contains two components, that are mixed together for approximately 30 seconds before pouring the mixed material into the hole.

KONGCRETE® can be used to install many different types of posts such as fence and sign posts, road and construction signs, as well as mailboxes, sports posts and poles, flagpoles and garden light posts.

[Click here to see a video of Kongcrete in action](#)

NO WEIGHT

NO WATER

NO MESS
**FULL STRENGTH
IN 2 HOURS!**

**SETS IN
3 MINS!**

**IDEAL FOR
FENCE POSTS**

+ 1001 OTHER USES

FAQ's

What is Kongcrete?

Kongcrete is a revolutionary new way to install fence & sign posts. It is a high strength alternative to concrete that is lightweight, does not require water, sets in 3 minutes and is extremely easy to use.

Kongcrete is a hydrophobic two-part composite backfill that expands to fill the peripheral void between a fence or sign post and the hole. Kongcrete expands immediately after mixing and reaches 50% of full strength in approximately 3 minutes. In approximately 15-30 minutes Kongcrete will already be quite hard. Fences or gates can be installed after the product completely sets in approximately 2 hours.

Will Kongcrete absorb water?

Kongcrete is waterproof when cured so will not absorb water. Kongcrete will also stop the post from rotting or corroding by providing a barrier between the wood and the water/soil. Due to its fast setting nature, Kongcrete is rain proof in a few minutes.

Is Kongcrete environmentally safe?

Once cured, Kongcrete becomes an inert solid and will not harm soil or water.

Can another Kongcrete kit be used on the top of the first one if required?

Yes, once the first kit has fully expanded another kit can be used on top.

What is the correct temperature for using Kongcrete?

Kongcrete is best used at 18 C - 25 C and the kits need to be stored at this temperature range for at least two hours before using. At lower temperatures, the kits will take longer to set and will produce less volume. At higher temperatures, the kits will set much faster, lowering the working time and will produce a higher volume, weaker composite.

What hole diameter is required when setting 100 mm x 100 mm post using Kongcrete?

As with any size post being set with Kongcrete the hole only needs to be slightly larger than the post itself. As Kongcrete is a pourable liquid when mixed it is easy to pour into a small cavity unlike concrete which requires a larger hole meaning more effort and material.

What type of posts can Kongcrete be used with?

Kongcrete can be used with a range of post types including Wood, Metal, Aluminium, Concrete, Vinyl and PVC and adheres to them better than concrete.

What happens if Kongcrete expands over the top of the hole?

Once cured excess Kongcrete can be removed by cutting with a handsaw or shovel.



NAVIGATOR®
SIGNPOST SYSTEM

Navigator Signpost System combines sharp, clean design lines with practical simplicity, providing a system that enables signmakers to create freestanding signs in a wide range of different styles.

Navigator Signpost System is designed to be used with 4mm Aluminium Composite Material (ACM) panels. Available in powdercoated white, satin black or anodised satin silver - corporate match colours available on request.



NAVIGATOR SIGNPOST SYSTEM 05

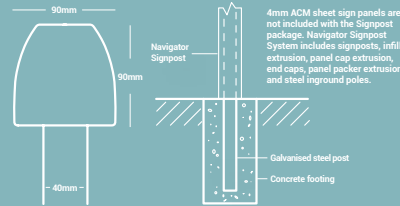
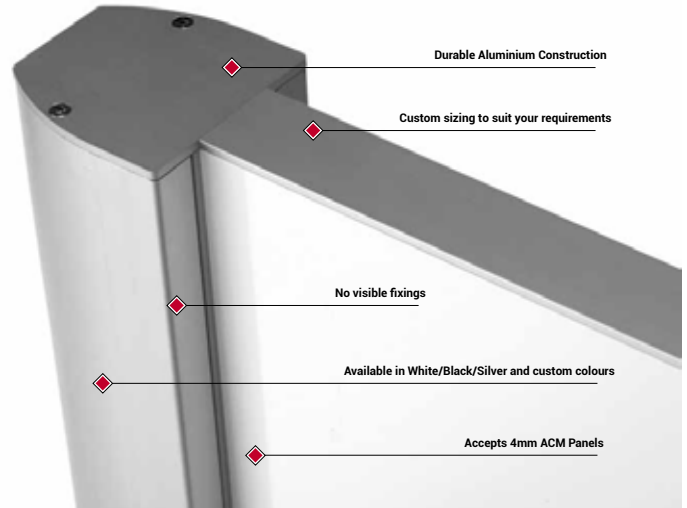

The system is modular, easy to alter and quick to assemble...

NAVIGATOR DIRECTIONAL POST SYSTEM 07



NAVIGATOR®
DIRECTIONAL POST SYSTEM

NAVIGATOR DIRECTIONAL POST SYSTEM is the easiest, neatest way of creating multidirectional signage. Designed to be very secure, yet easily changeable, the Directional Post System takes 4mm panels and is durable enough for the most demanding outdoor situations.

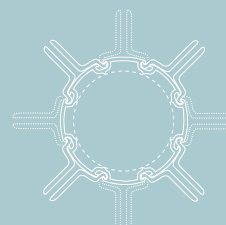

The easiest, neatest way of creating multidirectional signage!



NAVIGATOR WALLSIGN SYSTEM gives ACM sign panels a new dimension. Eliminate surface fixings and the unsightly cut edges of aluminium composite material panels with the Navigator Wallsign System.

The system provides a high level of finish for both interior and exterior wall signs and can be cut to suit almost any size panels – from small directional signs to large murals.

Available in 3 standard finishes – powdercoated white, or satin black, or anodised satin silver.

NAVIGATOR WALLSIGN SYSTEM 09

- 1 Affix rail extrusion to wall
- 2 Hang Wallsign panel
- 3 Screw in retention screws

Give ACM sign panels a new dimension!

NAVIGATOR®
DIRECTORY SYSTEM

Navigator 10 Directory System incorporates aluminium SignSlats and PaperChange panels or a combination of both in a wide range of size options, providing a versatile, modular directory system.

The innovative MCS – Multi Change System enables any SignSlat or PaperChange panel to be removed and replaced independently of other slats and panels. SignSlats and PaperChange panels are tamper proof yet easily changed using the changeout tools provided. Smart, clean design and innovative features make this system the ideal choice for your signage programme. A wide range of slat and panel options are possible – refer overleaf for more detail.

Completely secure with easy changeout.

NAVIGATOR DIRECTORY SYSTEM 11

Innovative PaperChange System allows easy changeout of printed material yet is tamper proof. Available in DLE, A4 Portrait, A4 Landscape, A3 Portrait and A3 Landscape.

MCS MULTI CHANGE SYSTEM®
Allows any SignSlat or PaperChange panel to be removed and replaced independently of other slats and panels using the changeout tools.

Aluminium SignSlats available in 4 standard heights – 30mm, 60mm, 90mm and 120mm.

SlidarSlat available in 30mm height. Ideal for indicating when meeting rooms are free or in use.

1. Release panel using changeout tools
2. Remove panel
3. Replace graphic
4. Replace panel

IN2SAFE

TRAFFIC SIGNAGE





VT7750



VT7740



VT7751



VT7752



VT7754



VT7756



VT7758L



VT7759L



VT7759R



VT7760



VT7762



VT7764



VT7765



VT7767



VT7768



VT7769



VT7701



VT7703



VT7715



VT7725



VT7726



VT7727



VT7728



VT7729



VT7731



VT7739



VT7704



VT7707



VT7730



VT7732



VT7733



VT7710



VT7702



VT7705



VT7711



VT7706



VT7713



VT7714



VT7716



VT7720



Flouro Bungy Flag
Code: PVF9025
- with Cords & Hooks
Size: 400 x 300mm



Flouro Flag
Code: PVF9067
- to fit over wooden Dowell
Size: 400 x 300mm

Fluorescent Yellow Flags (at least 400x300mm must be attached to indicate the Over Dimension portion on all Category 1 Vehicles or Loads. These are suitable for Day use only. If travelling at night they must be replaced with Retro-reflective Hazard Panels as below.



LH

Reflective Hazard Panels - Day/Night Use

Single Sided Left Hand Panel Code: VT7900SL
Single Sided Right Hand Panel Code: VT7900SR
Double Sided Panel Code: VT7900D

Size: 400 x 300mm
Material: ACM (4mm Aluminium Composite Material)



RH



Narrow Reflective Hazard Panels - Day/Night Use

Single Sided Left Hand Panel Code: VT7899SL
Single Sided Right Hand Panel Code: VT7899SR
Double Sided Panel Code: VT7899D

Size: 200 x 400mm
Material: ACM (4mm Aluminium Composite Material)



Retro-reflective Hazard Warning Panels with the dimensions as shown can be used on Category 1 & 2 Vehicles or Loads. These are suitable for Day or Night Use. Note: You must not display Hazard Warning Panels unless required to do so by the Vehicle Dimensions and Mass Rule.



Oversize Sign - Code: VT7901AA

Size: 1100 x 300mm
Material: ACM (4mm Aluminium Composite Material)
Suits: Day/Night Use



Oversize Sign - Code: VT7901AV

Size: 1100 x 300mm
Material: Flexible PVC (Roll-up)
Suits: Day only Use



Over Sign - Code: VT7902AA

Size: 550 x 300mm
Material: ACM (4mm Aluminium Composite Material)
Suits: Day/Night Use



Size Sign - Code: VT7903AA

Size: 550 x 300mm
Material: ACM (4mm Aluminium Composite Material)
Suits: Day/Night Use

Oversize Signs are required by the Vehicle Dimensions & Mass Rule on Vehicles or Loads over 3.1M Wide. They must only be displayed if required by the above Rule. These signs are suitable for both Category 1 & 2 Vehicles or Loads.



Pilot Vehicle/Wide Load Follows Double Sided Sign

Code: VT7905AA

Size: 1100 x 520mm

Material: ACM (4mm Aluminium Composite Material)

Suits: Day/Night Use



Text	Code	Size	Material	Usage
PILOT VEHICLE	VT7904AAB	1100 x 520mm	ACM	Day / Night
DANGER SLOW DOWN	VT7906AA	1100 x 600mm	ACM	Day / Night
WIDE LOAD FOLLOWS	VT7907AA	1100 x 520mm	ACM	Day / Night
WIDE LOAD AHEAD	VT7908AA	1100 x 520mm	ACM	Day / Night
HOUSE FOLLOWS SIGN	VT7909AA	1100 x 520mm	ACM	Day / Night
HOUSE AHEAD SIGN	VT7909AA	1100 x 520mm	ACM	Day / Night
LONG LOAD FOLLOWS SIGN	VT7911AA	1100 x 520mm	ACM	Day / Night
LONG LOAD AHEAD SIGN	VT7912AA	1100 x 520mm	ACM	Day / Night
CRANE FOLLOWS SIGN	VT7913AA	1100 x 520mm	ACM	Day / Night
CRANE AHEAD SIGN	VT7914AA	1100 x 520mm	ACM	Day / Night



Red/Green 360mm Traffic Control Wands
Code: VT7957



Stop/Slow Paddle
Code: VT7851R
Size: 300mm OD
300mm Handle

Need more information on the NZ Over Dimension requirements?

Get a copy of fact sheet 53 off <https://www.nzta.govt.nz/assets/resources/factsheets/53/docs/53-overdimension.pdf>
 • Phone 0800 OVERSIZE (0800 683 774)
 • Check out the NZTA website: www.nzta.govt.nz or email opia@nzta.govt.nz
 This catalogue should not be used as a substitute for professional advice regarding your specific requirements.



Stop/Go Paddle
Code: VT7850R
Size: 450mm OD
1550mm Handle

NZTA Compliant Road Cones

Code: VT7851R
Size: 450mm (Compliant only for Road Marking)

Code: VT7851R
Size: 900mm



Standard LED Beacon
Code: VFB7000AM
- 10-30V
- Cig Plug & Mag Base
Size: 85 x 90mm



Low Profile LED Beacon
Code: VFB7001AM
- 10-30V
- Cig Plug & Mag Base
Size: 85 x 50mm



Large LED Beacon
Code: VFB7002AM
- 10-30V
- Cig Plug & Mag Base
Size: 125 x 135mm



Pole Mount LED Beacon
Code: VFB7000AP
- 10-30V
- DIN Pole Mount
Size: 85 x 180mm



HPMV "H" Sticker

Code: VT7920RS

Size: 200 x 200mm

Material: SAV (Self Adhesive)

HPMV "H" Sign

Code: VT7920VP

Size: 295 x 295mm

Material: PVC (2mm Rigid PVC Plastic)

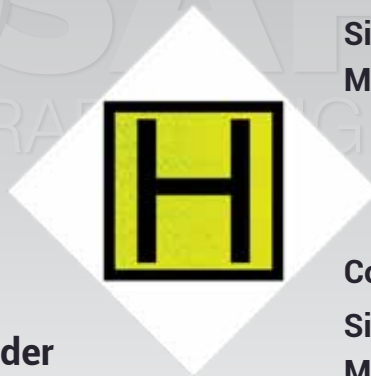

Code: VT7920VA

Size: 295 x 295mm

Material: ACM (4mm Aluminium Composite Material)

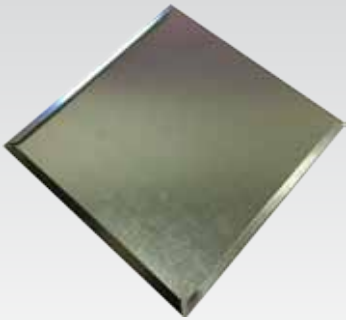

Galvanised Holder

Code: VH7500G

Size: 295x295mm

Material: Galvanised Steel

Suits: HPMV "H" Signs

**0800 LOGTRUCK
TRUCK MC67**

0800 Log truck Sticker

**Code: VT7930 (SAV) Sticker
VT7930A (ACM) Sign**

Size: 722x278mm



**0800
LOGTRUCK
MC67**

0800 Log truck Sticker

**Code: VT7931 (SAV) Sticker
VT7931A (ACM) Sign**

Size: 800x381mm

0800 LOGTRUCK 5302

0800 Log truck Sticker

**Code: VT7932 (SAV) Sticker
VT7932A (ACM) Sign**

Size: 1000x100mm

**LONG
VEHICLE**

Code: VT7922

Size: 500x250mm

**DO NOT OVERTAKE
TURNING VEHICLE**

Code: VT7923

Size: 500x250mm

**THIS VEHICLE IS
SPEED LIMITED
TO MAXIMUM** **90**
km/h

Code: VT7503

Size: 450 x 200mm

THIS
VEHICLE IS
SPEED LIMITED TO
90
KPH

Code: VT7921

Size: 300mm

For HAZCHEM Signage for Transport of Dangerous Goods, see page 42.

For full details of your legal requirements consult the NZTA Website for DG Transport Requirements!



WARNING
**RISK OF FALL
ON ENTRY & EXIT**
- MAINTAIN 3 POINTS OF CONTACT
- NEVER JUMP OFF MACHINE
- CLIMB UP FORWARD
- CLIMB DOWN BACKWARDS
- ENSURE STEPS ARE CLEAN

VW7007

WARNING
APPROVED HEARING PROTECTION
MUST BE WORN IF NOISE IN CAB EXCEEDS 85db

VW7018

WARNING
BEWARE OF CHAIN SHOT

VW7019

WARNING
35°
MAXIMUM 35 DEGREE SLOPE

VT7936

WARNING
45°
MAXIMUM 45 DEGREE SLOPE

VT7937

WARNING
Don't give yourself OOS!!
(Occupational Overuse Syndrome)
Remember these simple rules to prevent OOS...
- Micro-pause: Let go of your controls for about 15 seconds, every 5 minutes or so. Breathe up & shake your hands & arms. At the same time stare at something a long distance away.
- Take short breaks, of about 2 minutes every half hour: stretch arms & move about.
- Get out of the cab every hour, even if it's only for a minute or so!
- Don't over-reach for any controls: adjust your seat so it is as close to the controls as possible.
- Job rotation: Give somebody else a go on your machine, so you can get out of the cab more often.
- Ensure your machine is well maintained, to minimise vibration, don't use vibrating controls.

VW7020

Square Self Adhesive Vinyl Stickers available in 4 sizes: Use the Below letters as a suffix on the code when ordering. GS - 100x100mm, LS - 150x150mm, RS - 200x200mm, VS - 295x295mm

WARNING
**SERVICE BRAKE
MUST BE APPLIED
AT ALL TIMES**

VW7024OS

Size: 100 x 75mm

VW7024MS

Size: 200 x 150mm

Rope tie down only

VG7706OS

Size: 100 x 30mm

VG7706MS

Size: 200 x 60mm

EMERGENCY EXIT **BREAK GLASS IN EMERGENCY**

Emergency Exit Sticker

Code: VT7935

Size: 550 x 100mm

IN2SAFE

LOCKOUT SYSTEMS

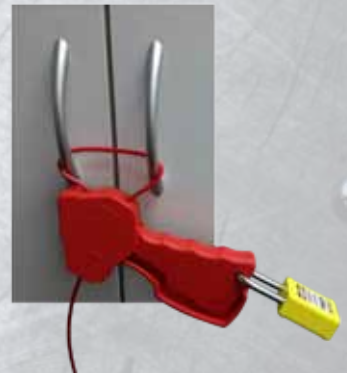

IN2SAFE Lockout Padlock - Key Management System

The IN2SAFE Lockout Padlocks come with both Keyed Different and Keyed Alike options, along with a Master key system. This allows a high level of customisation for complex lockout systems with Multi level access and a wide range of different Groups. See below for Diagrams of each Key option.

Keyed Different

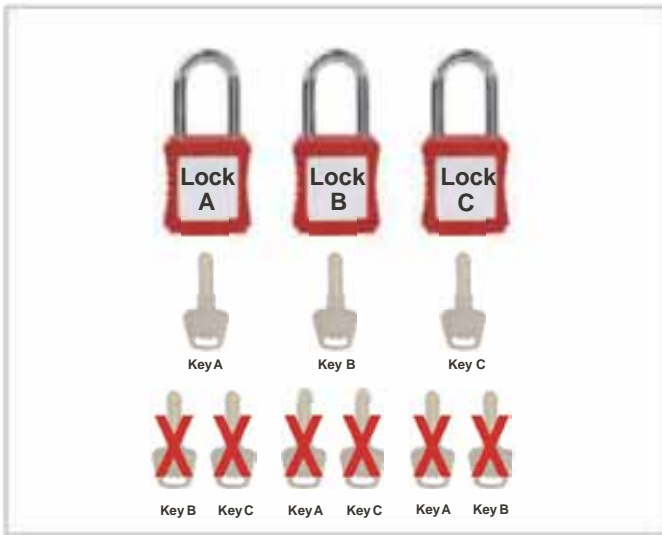

Each Lock has only One Key. The Key does not open any other Locks. Ideal for Maximum Safety in High Risk applications. Only the Lock owner can remove the Lock with no risk of accidental removals.

Keyed Alike

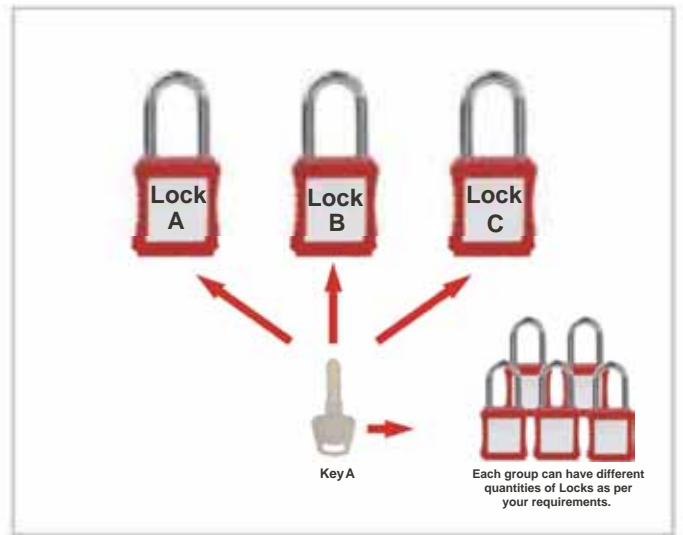

Each Lock within a designated group takes the same Key. The Key will open all Locks within the Group. Multiple Groups can be set up with different keys. Ideal for situations where individuals need multiple padlocks. Requires careful Management to ensure no crossover of Keyed alike Padlocks between staff.

Keyed Different with Master Key

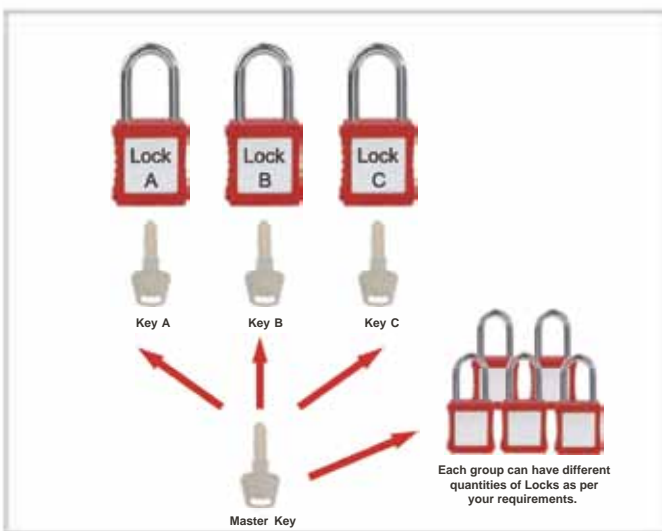

Exactly the same principle as the standard Keyed Different Locks, except there is a Master Key which will open all Locks in the Group. Ideal for Plant Shutdown situations. A designated Supervisor has the ability to remove any locks left after the job is finished. Must be managed very carefully to minimise the risk associated with this type of system.

Keyed Alike with Master Key

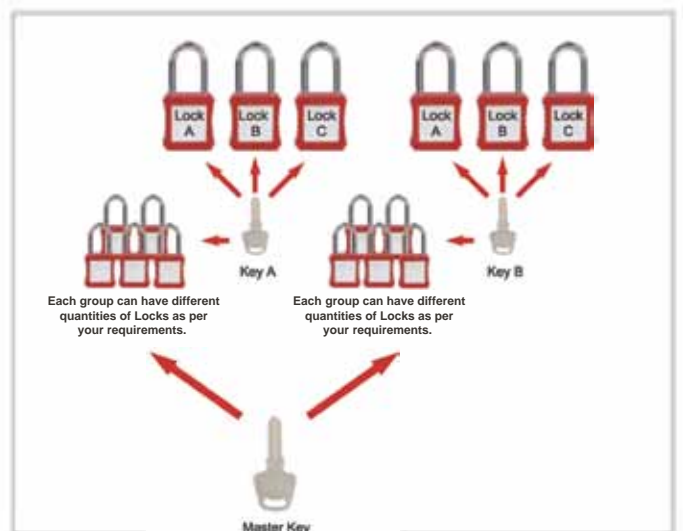

Exactly the same principle as the standard Keyed Alike Locks, except there is a Master Key which will open all Groups. Also ideal for Plant Shutdown situations. A designated Supervisor has the ability to remove any locks left after the job is finished. Must be managed very carefully to minimise the risk associated with this type of system.

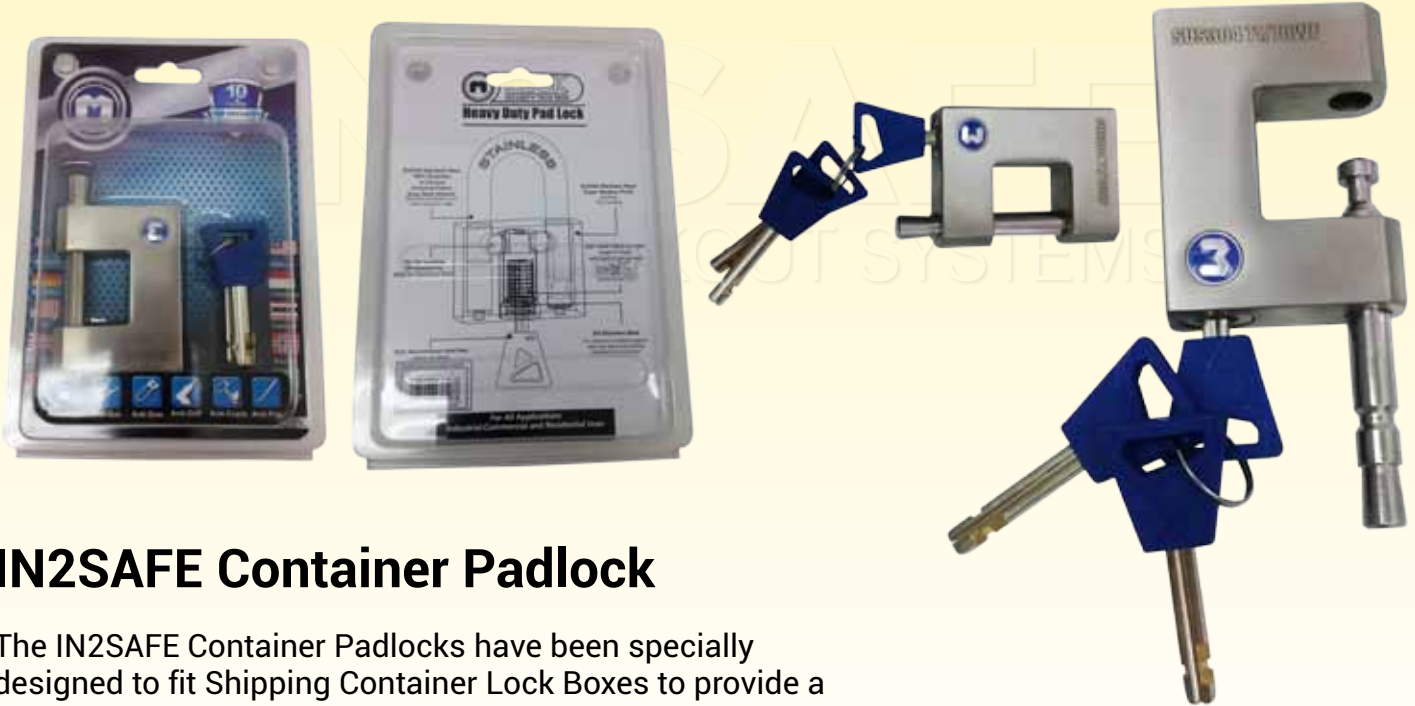

IN2SAFE Container Padlock

The IN2SAFE Container Padlocks have been specially designed to fit Shipping Container Lock Boxes to provide a secure and easy to use locking system. Locks are available in both Keyed Different & Keyed Alike sets.

VLP1000-KA (Keyed Alike) VLP1000-KD (Keyed Different)

IN2SAFE Lockout Padlock - Unique ID Systems

The IN2SAFE Lockout Padlocks can be specified with Custom Printed Labels. These labels can support a number of Variable Printed fields, including a Photo ID, Name, Mobile Number and any other relevant information to allow easy Identification. This can significantly reduce the time taken to resolve the issue of Padlocks left in place after the job is completed. Especially helpful in Planned shutdown situations where it is important to re-energise and re-start plant as quickly as possible.

Front View
with Standard Label

Back View
with Custom ID Label

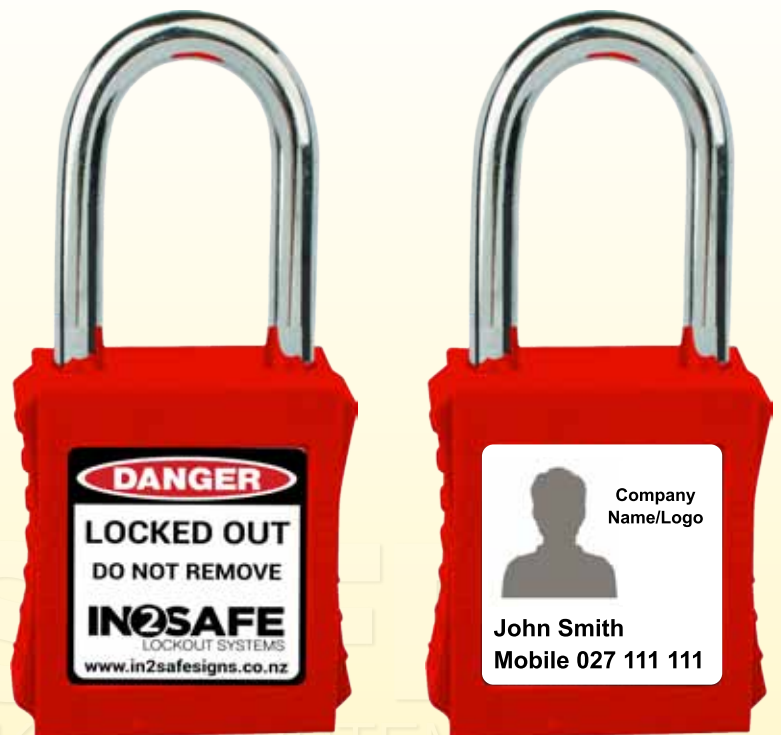

VLP700 - Standard Steel Shackle Padlock

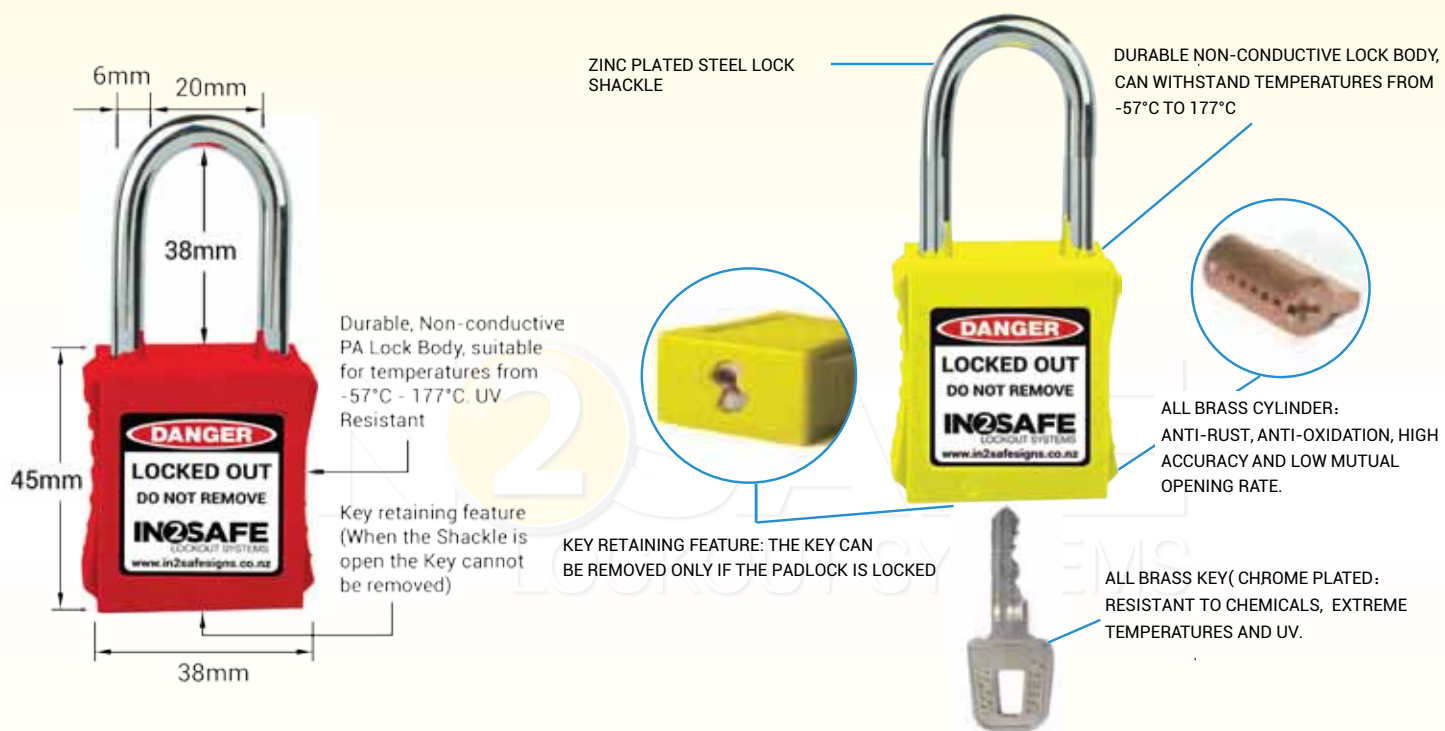

Padlock Colour	Keyed Alike (KA) Padlock Code	Keyed Different (KD) Padlock Code	Master Key Code (Suits KA Padlocks)	Master Key Code (Suits KD Padlocks)
Red	VLP700-KA-RD	VLP700-KD-RD	VLP700-KA-RD-MK	VLP700-KD-RD-MK
Yellow	VLP700-KA-YE	VLP700-KD-YE	VLP700-KA-YE-MK	VLP700-KD-YE-MK
Green	VLP700-KA-GN	VLP700-KD-GN	VLP700-KA-GN-MK	VLP700-KD-GN-MK
Blue	VLP700-KA-BU	VLP700-KD-BU	VLP700-KA-BU-MK	VLP700-KD-BU-MK
Orange	VLP700-KA-OR	VLP700-KD-OR	VLP700-KA-OR-MK	VLP700-KD-OR-MK
Purple	VLP700-KA-PU	VLP700-KD-PU	VLP700-KA-PU-MK	VLP700-KD-PU-MK
Black	VLP700-KA-BK	VLP700-KD-BK	VLP700-KA-BK-MK	VLP700-KD-BK-MK
White	VLP700-KA-WH	VLP700-KD-WH	VLP700-KA-WH-MK	VLP700-KD-WH-MK

VLP701 - Long Steel Shackle Padlock

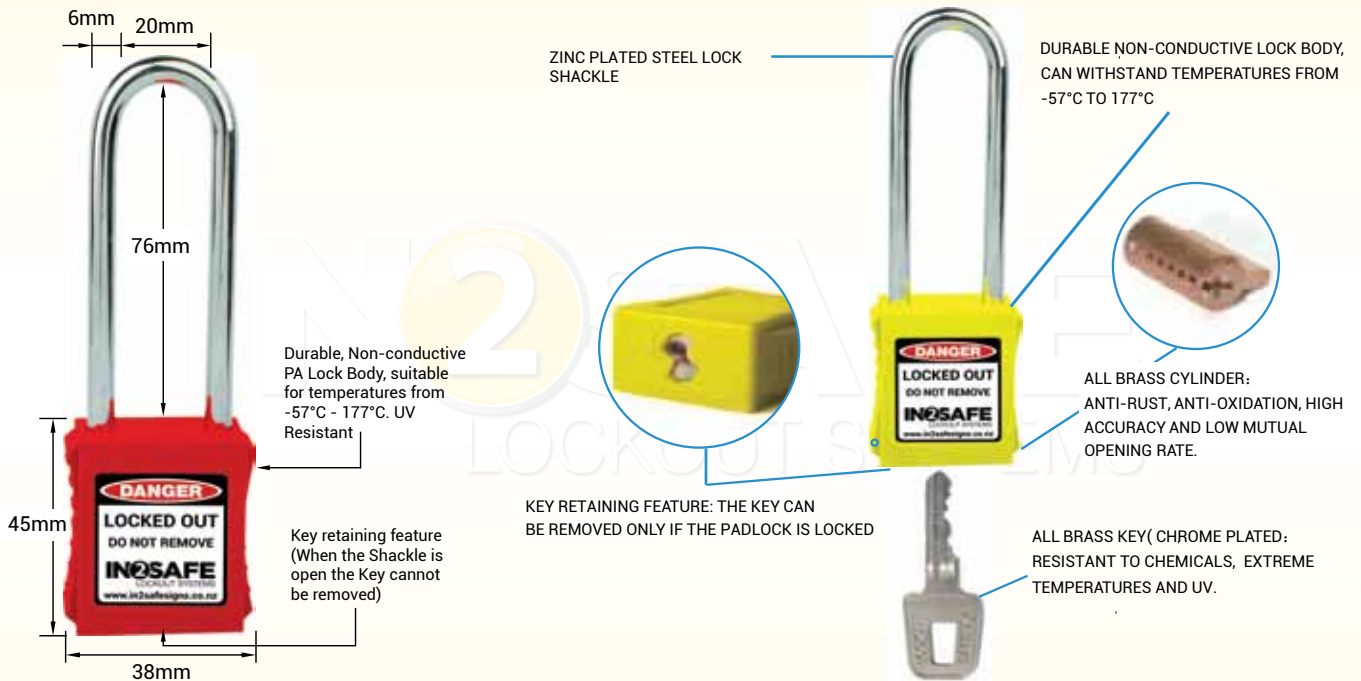

Padlock Colour	Keyed Alike (KA) Padlock Code	Keyed Different (KD) Padlock Code	Master Key Code (Suits KA Padlocks)	Master Key Code (Suits KD Padlocks)
Red	VLP701-KA-RD	VLP701-KD-RD	VLP701-KA-RD-MK	VLP701-KD-RD-MK
Yellow	VLP701-KA-YE	VLP701-KD-YE	VLP701-KA-YE-MK	VLP701-KD-YE-MK
Green	VLP701-KA-GN	VLP701-KD-GN	VLP701-KA-GN-MK	VLP701-KD-GN-MK
Blue	VLP701-KA-BU	VLP701-KD-BU	VLP701-KA-BU-MK	VLP701-KD-BU-MK
Orange	VLP701-KA-OR	VLP701-KD-OR	VLP701-KA-OR-MK	VLP701-KD-OR-MK
Purple	VLP701-KA-PU	VLP701-KD-PU	VLP701-KA-PU-MK	VLP701-KD-PU-MK
Black	VLP701-KA-BK	VLP701-KD-BK	VLP701-KA-BK-MK	VLP701-KD-BK-MK
White	VLP701-KA-WH	VLP701-KD-WH	VLP701-KA-WH-MK	VLP701-KD-WH-MK

VLP702 - Standard Nylon Shackle Padlock

Padlock Colour	Keyed Alike (KA) Padlock Code	Keyed Different (KD) Padlock Code
Red	VLP702-KA-RD	VLP702-KD-RD
Yellow	VLP702-KA-YE	VLP702-KD-YE

** Dimensions & Specifications are the same as VLP700, apart from the Nylon Shackle for Non-Conductive Applications.



VLP702 - Standard Nylon Shackle Padlock

Padlock Colour	Keyed Alike (KA) Padlock Code	Keyed Different (KD) Padlock Code
Red	VLP703-KA-RD	VLP703-KD-RD
Yellow	VLP703-KA-YE	VLP703-KD-YE

** Dimensions & Specifications are the same as VLP701, apart from the Nylon Shackle for Non-Conductive Applications.



VLP704 - Steel Cable Padlock

Keyed Alike Code: VLP704-KA-RD
Keyed Different Code: VLP704-KD-RD

- > 3mm Diameter Steel Cable
- > 150mm Cable Length



VLP705 - Economy Steel Short Shackle Padlock

Only available as Keyed Different!

Code: VLP704-KD-RD

- > 6mm Diameter Shackle
- > Shackle opening 20mm high x 20mm wide



Butterfly Valve Lock

Code	Size
VLV701-1	9.5-32mm (0.375-1.25")
VLV701-2	38-63.5mm (1.5-2.5")
VLV701-3	50-203mm (2-8")

The butterfly valve lock is made up from three parts as shown below.



Different ways to use a Butterfly Valve Lock

Gate Valve Lockout

Code	Size
VLV702-1	25-63.5mm (1-2.5")
VLV702-2	63.5-127mm (2.5-5")
VLV702-3	127-165mm (5-6.5")
VLV702-4	165-254mm (6.5-10")
VLV703-A	25-165mm (1-6.5") (universal size)

The gate valve lockout can be used in two different ways as shown below.



Example of how the gate valve lockout is used:

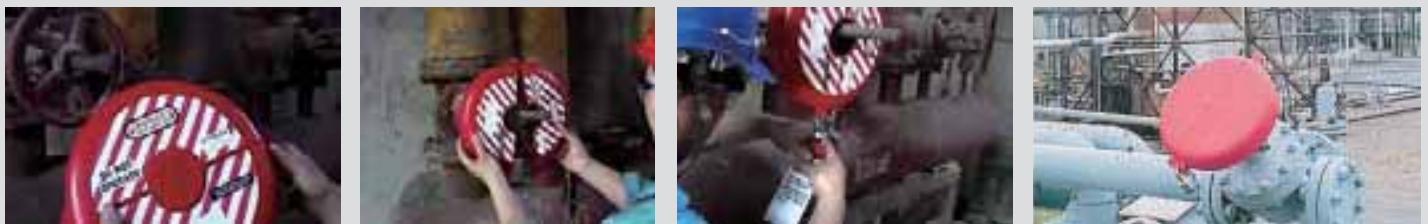

Ball Valve Lockout

Code	Size
VLV700-1	12.5-63.5mm (0.5-2.5")
VLV700-2	50-203mm (2-8")



Example of how the ball valve lockout is used:

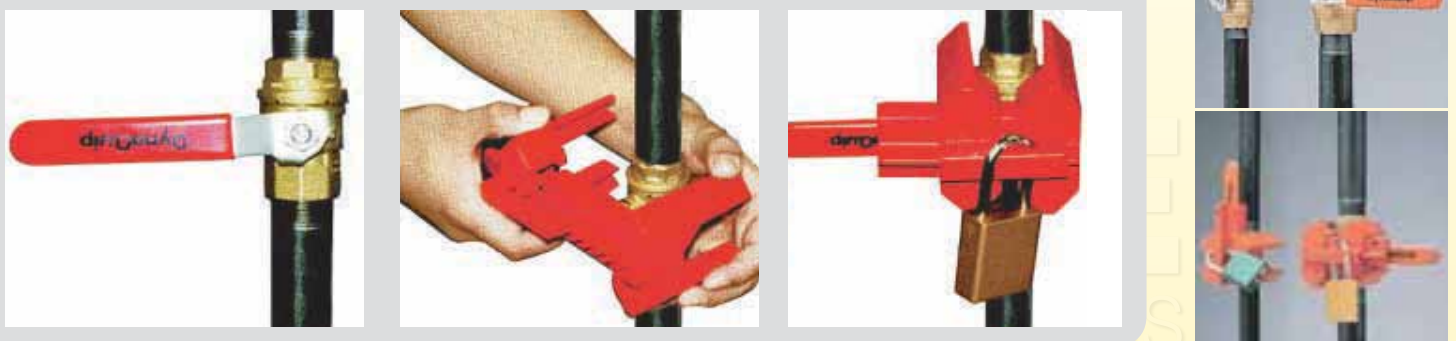

Steel Lockout Hasp

Code: VLH701-6-25

Size: 25mm

> 6 locks

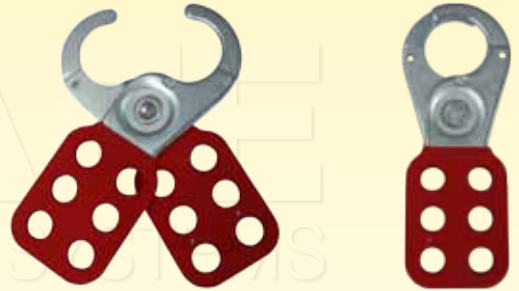

Steel Lockout Hasp

Code: VLH701-6-38

Size: 38mm

> 6 locks



Steel Lockout Hasp with Anti-Twist Hooks

Code: VLH702-6-38

Size: 38mm

> 6 locks



Aluminium Lockout Hasp

Code: VLH703-6-38

Size: 38mm

> 6 locks



Nylon Lockout Hasp

Code: VLH704-6-1

Size: 41.5 x 193mm

- > 6 locks
- > 6.5mm Shackle



Nylon Lockout Hasp

Code: VLH704-6-2

Size: 43 x 173mm

- > 6 locks
- > 6mm Shackle



Nylon Lockout Hasp

Code: VLH705-4-3

Size: 61 x 107mm

- > 4 locks
- > 3mm Shackle



Nylon Lockout Hasp

Code: VLH705-4-6

Size: 61 x 107mm

- > 4 locks
- > 6mm Shackle



Mini Circuit Breaker Lockout

Code: VLE700-IN

> Pin in



Mini Circuit Breaker Lockout

Code: VLE700-OUT

> Pin out



Example of how electrical lockouts pin in and pin out are used:

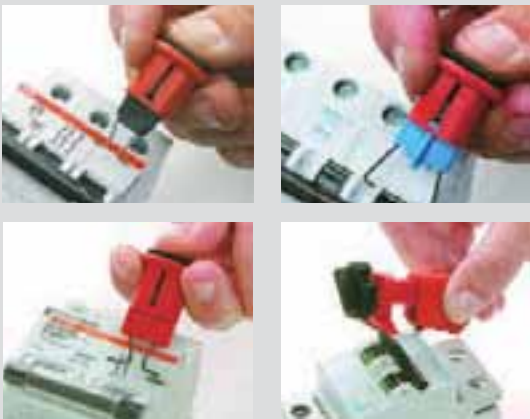

Mini Circuit Breaker Lockout

Code: VLE701-1

Size: 45 x 25 x 10mm



Mini Circuit Breaker Lockout

Code: VLE701-2

Size: 51 x 25 x 23mm



Mini Circuit Breaker Lockout

Code: VLE701-3

Size: 51 x 21 x 23mm



Mini Circuit Breaker Lockout

Code: VLE701-4

Size: 125 x 63 x 40mm



Example of how electrical lockouts are used:



Electrical Plug Lockout

Code: VLE702

Size: 97 x 95 x 170mm



Universal Cable Lockout

Code: VLE703

Size: 3.5mm cable x 2.4m long

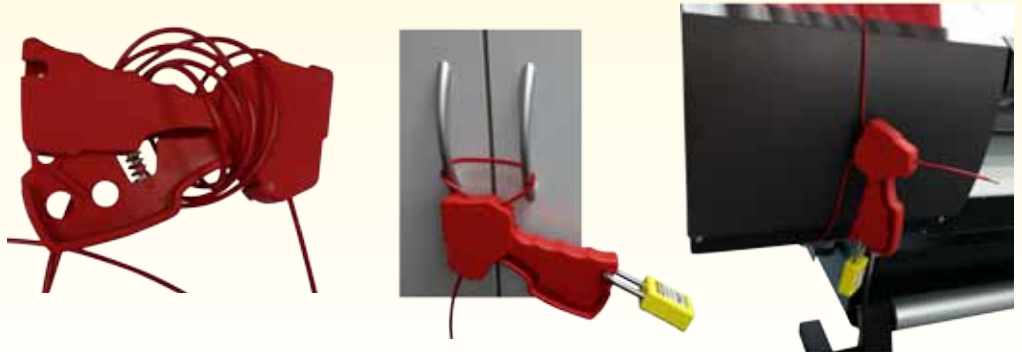

Bag Style Lockout

Code: VLE705

Size: 440 x 245mm
Bag opening width 220mm



Adjustable Cable Lockout

Code: VLE704

Size: 6mm cable x 1.8m long



Pneumatic Lockout

Code: VLA700

Size: 6.4 x 9.5 x 12.7mm
Suits 6.4mm, 9.5mm & 12.7mm male fittings



Lockout Belt Bag

Code: VLB700

Size: 180 x 50 x 150



Lockout Carry Bag

Code: VLB701

Size: 310 x 200 x 23



Lockable Key Station

Code: VLK700

- > 30 key
- > Metal cabinet



Lockable Key Station

Code: VLK701

- > 80 key
- > Metal cabinet



Lockable Station

Code: VLS700

> 5 - 10 locks



Lockable Station

Code: VLS701

> 10 - 20 locks



Basic Lockout Padlock Holder

Code	Size
VLS710	Fits 5 padlocks
VLS711	Fits 10 padlocks
VLS712	Fits 15 padlocks
VLS713	Fits 20 padlocks

IN2SAFE